

# VIMA



 Catalogo Generale

 General Catalogue

 Catalogue Général



DAL 1950 I PROFESSIONISTI DELL'ASCIUGATURA

**VAMA**

THE AIR-DRYING PROFESSIONALS SINCE 1950

LES PROFESSIONNELS DE L'AIR CHAUD DEPUIS 1950

[www.vama.it](http://www.vama.it) - [info@vama.it](mailto:info@vama.it)



🇮🇹 É con la passione e la determinazione di ogni nostra azione quotidiana che possiamo raggiungere anche gli obiettivi più difficili e le mete più lontane, senza mai dimenticare l'etica, i limiti, le responsabilità che da sempre contraddistinguono una realtà "Family Style" come la nostra. Con questa consapevolezza, per volgersi non unicamente al conseguimento del profitto ma anche alla creazione di un mondo migliore, viviamo l'obiettivo della nostra impresa come quello di una famiglia. Investiamo ogni giorno insieme a voi per raggiungere vette sostenibili.

🇬🇧 We put passion and determination in all our daily actions in order to reach even the hardest and furthest goals, always keeping in mind ethics, limits, responsibilities that always mark a "Family Style" company like our own. With this awareness, not only directed to make profit, but also to create a better world, we live the goal of our company like the one of a family. We invest every day together with you to achieve sustainable targets.



🇫🇷 C'est avec passion et détermination de tous nos gestes quotidiens que nous pouvons atteindre les objectifs même les plus difficiles et plus loin encore. Sans jamais oublier l'éthique, les limites, les responsabilités qui ont toujours accompagné une réalité "Family Style" comme la nôtre. Avec cette prise de conscience, non seulement dirigé vers la réalisation du profit, mais aussi pour créer un monde meilleur, nous vivons dans le but de notre société en tant que partie d'une famille. Nous investissons chaque jour avec vous pour atteindre des pics durables.

Davide Romano

# Asciugamani Hand dryers Sèche-mains

## ECO-JET DRYERS



Xdry 	11		
Tornado	17	Smart Jet	37
Stream dry UV 	23	Laser Flow	42
Eco Stream Eco Flow	29	Vision Air	48

## ASCIUGAMANI IN ACCIAIO

STAINLESS STEEL HAND DRYERS - SÈCHE-MAINS EN ACIER



Ariel	55
-------	----

## ASCIUGAMANI IN ABS





ABS HAND DRYERS - SÈCHE-MAINS EN ABS



Unik	59	AEA - Turbotime - Turbotronic	62
------	----	-------------------------------	----

# Asciugacapelli Hair dryers - Hotel line *Linea Hotel* Sèche-cheveux - Ligne hotel



Comfort Pro 	66	Tiny	80
Viento Space 	68	Atelier Shaver	81
Elegant Pro	70	Accessori Bagno	82
Viento	72	Casseforti 	88
Pro phon	75	Attrezzature	89
Eternity	76	Minibar A+ 	90
Fit Phon	78		



## ASCIUGACAPELLI

HAIR DRYERS - SÈCHE CHEVEUX

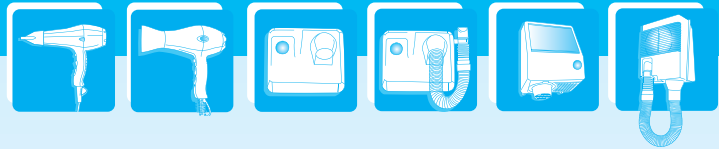

Pro Phon 1800 W .....	94		
Fit Phon 1000 W .....	94	Unik Air - Acea .....	101
Stream Dry Hair .....	95	Turbo 3 .....	103

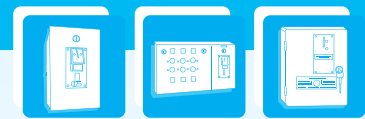

Gettoniere .....	104
Coin Systems - Monnyeurs	
Colonna Doccia .....	107
Shower Collumn	
Rubinetteria .....	108
Colonne de Douche	

## Washroom Equipments **Linea Igiene** Equipements Sanitaires



Linea INOX .....	111
Maniglioni murali .....	113
Linea ABS .....	114

## ALLEGATI / ANNEXES



Altezza installazione raccomandata / Recommended installation height / Hauteur d'istallation recommandée .....	117
--	-----





***ASCIUGAMANI***  
*Hand Dryers - Sèche-mains*





# Asciugamani - Hand dryers - Sèche-mains

GUIDA VELOCE ALLA SCELTA / HAND DRYERS QUICK GUIDE / GUIDE RAPIDE POUR SÈCHE-MAINS

## COME SCEGLIERE / HOW TO CHOOSE / COMME CHOISIR?



- VAMA®** offre una **GAMMA COMPLETA** di asciugamani elettrici, che comprende sia i modelli **TRADIZIONALI** che quelli più **INNOVATIVI** come **VELOCITÀ DI ASCIUGATURA & RISPARMIO ENERGETICO (ECO – JET)**. L'intera gamma è composta da 3 range di asciugamani, suddivisi in 9 famiglie, disponibili in una grande varietà di finiture e opzioni.
- VAMA®** offers a **COMPLETE RANGE** of **TRADITIONAL** and **ECO – JET** hand dryers. We manufacture and commercialize 3 kind of hand dryers, divided into 9 families, available with different features and finishes.



### ASCIUGAMANI ECO-JET ECO-JET DRYERS

### ASCIUGAMANI TRADIZIONALI TRADITIONAL HAND DRYERS

TOP DI GAMMA  
TOP RANGE



ALTA AFFLUENZA  
HIGH TRAFFIC



ARIEL



ENTRY LEVEL

smart jet  
mini



U-nik™ AEA TURBOTRONIC

**VELOCITA' DI ASCIUGATURA ULTRA RAPIDA**  
**RISPARMIO ENERGETICO**  
**IGIENE: FILTRO EPA E11 (tutti i modelli),**  
**LAMPADA UV (Laser Flow, Stream Dry)**  
**VASCHETTA RACCOLTA ACQUA**  
**(Vision Air, Tornado PROtech, X Dry)**

Ideali per clienti **TRADIZIONALISTI** o con requisiti particolari (es. silenziosità = UNIK)



# ASCIUGAMANI - HAND DRYERS - SÈCHE-MAINS

GUIDA VELOCE ALLA SCELTA / HAND DRYERS QUICK GUIDE / GUIDE RAPIDE POUR SÈCHE-MAINS



## 🇮🇹 L'ASCIUGAMANI PIU' ECONOMICO, PIU' VELOCE, PIU' ROBUSTO E ANCHE PIU' SILENZIOSO... TUTTO IN UN'UNICA SOLUZIONE ?!?

Non esiste l'asciugamani migliore, esiste l'asciugamani con le caratteristiche migliori rispetto al budget di spesa e al contesto di utilizzo (numero di utilizzi giornalieri; concentrazione o meno degli utilizzi in alcune fasce orarie; problemi di vandalismo; requisiti di design; ricerca di risparmio e innovazione...)

- **VELOCITA' DI ASCIUGATURA E SILENZIOSITA'\***: più veloce si asciuga più rumore si produce. È necessario scegliere quale di questi due requisiti sia quello fondamentale.
- **FORTE UTILIZZO\***: in caso di affluenza elevata e/o molto concentrata in determinate fasce orarie si dovrà optare per modelli con prestazioni superiori a quelli base.
- **MASSIMO RISPARMIO ENERGETICO: RISCALDAMENTO PROGRESSIVO O IMMEDIATO?** vedi tabella a piè di pagina\*\*

## 🇬🇧 THE CHEAPEST, FASTEST, STRONGEST AND MOST NOISELESS HAND DRYER... ALL IN ONE ?!?

There is no hand dryer that's the best in every respect, there is the hand dryer that has the best features, depending on budget and context of use (number of dryings per day; lots of drying in a little time; vandalism; design requirements, saving and innovation seeking...)

- **DRYING SPEED AND NOISELESSNESS\***: the faster it dries the more noise it makes, it's necessary to choose which of the two features is the most important for you.
- **HEAVY TRAFFIC\***: in case of heavy traffic you should choose a superior performance model instead of the basic ones.
- **BEST ENERGY SAVING: GRADUAL OR IMMEDIATE HEATING?** Please consult the chart at the foot of the page for more information\*\*

## 🇫🇷 LE SÈCHE-MAIN ÉLECTRIQUE PLUS ECONOMIQUE, PLUS RAPIDE, PLUS ROBUSTE, PLUS SILENTIEUX... SOLUTION TOUT EN UN ?!?

Il n'y a pas un dispositif mieux que d'autres, mais il exist là solution meilleure par rapport au budget et le contexte d'utilisation (nombre d'utilisations par jour, concentration des usages dans certaines horaires, problèmes de vandalisme, exigences de design, recherche d'épargne et d'innovation...)

- **VITESSE DU SÉCHAGE ET BRUIT\***: le plus rapide le séchage, le plus de bruit est produit; vous devez choisir lequel de ces deux exigences est la fondamentale.
- **USAGE INTENSIF\***: Si vous l'utilisez fortement ou de façon très concentré en certains moments, vous devrez opter pour des modèles avec des performances supérieures que les modèles standard.
- **ÉCONOMIE D'ÉNERGIE MAXIMALES: CHAUFFAGE PROGRESSIF OU IMMEDIATE?** le tableau a la fin de cette page\*\*

### 🇮🇹 OPZIONI RISCALDAMENTO ARIA\*\*

### 🇬🇧 AIR HEATING OPTIONS\*\*

### 🇫🇷 OPTION DE CHAUFFAGE DE L'AIR\*\*

VISION AIR			🇮🇹 NESSUNA RESISTENZA ELETTRICA: RISCALDAMENTO PROGRESSIVO CON L'UTILIZZO
TORNADO PROTECH			🇬🇧 NO HEATING ELEMENT: PROGRESSIVE AIR HEATING
ECO STREAM ECO FLOW			🇫🇷 ABSENCE DE RÉSTANCE ÉLECTRIQUE: CHAUFFAGE AIR PROGRESSIF

ECO STREAM ECO FLOW LASER FLOW			🇮🇹 ARIA CALDA IMMEDIATA
SMARTJET MINI			🇬🇧 IMMEDIATELY HOT AIR!!!
ARIEL			🇫🇷 AIR CHAUD IMMEDIATEMENT!!!
UNIK			

### 🇮🇹 MODELLI & CARATTERISTICHE\*

### 🇬🇧 MODELS & FEATURES\*

### 🇫🇷 MODÈLES & CARACTÉRISTIQUES\*

<b>VELOCITÀ ASCIUGATURA</b> DRYING TIME / TEMPS DE SÉCHAGE	★★★★★
<b>RISPARMIO ENERGETICO</b> ENERGY SAVING / ÉPARGNE ÉNERGETIQUE	★★★★★
<b>SILENZIOSITÀ</b> NOISELESS / SILENCIEUX	★★★★★
<b>DESIGN</b>	★★★★★
<b>ANTIVANDALISMO</b> ANTIVANDALISM / ANTIVANDALISME	★★★★★

- 🇮🇹 Per orientarti nella scelta consulta le tabelle con le caratteristiche di ciascun modello
- 🇬🇧 Choosing the right dryer? Have a look at 5 star tables of each model
- 🇫🇷 Pour vous guider dans le choix merci de consulter les tableaux avec les caractéristiques de chaque modèle

# ASCIUGAMANI ECO-JET A RISPARMIO ENERGETICO

JET HAND DRYERS, ENERGY SAVING

SÈCHE-MAINS JET, ÉCONOMIE D'ÉNERGIE MAXIMALE

**LASER**  
FLOW

BRUSHLESS = ZERO CARBON  
**100% GREEN**  
TOP PERFORMANCE



VISIONair

TORNADO  
Rotech

ECO  
Stream

ECO  
Flow

smart jet  
mini

**IGIENICO**  
**HYGIENIC / HYGIÉNIQUE**



**GLI ASCIUGAMANI ASSOLUTI:  
ULTRARAPIDI - ECONOMICI - ECOCOMPATIBILI**

**NEW STYLE OF HAND-DRYING: GO FAST & SAVE TIME,  
SAVE MONEY, ENERGY & THE PLANET**

**LE NOUVEAU SENS DE SÉCHAGE:  
ULTRA-RAPIDE - ÉCONOMIQUE - ÉCOLOGIQUE**

CONSUMI PER CICLO - CONSUMPTION PER CYCLE - COMPARAISON DES COÛTS DE SÉCHAGE

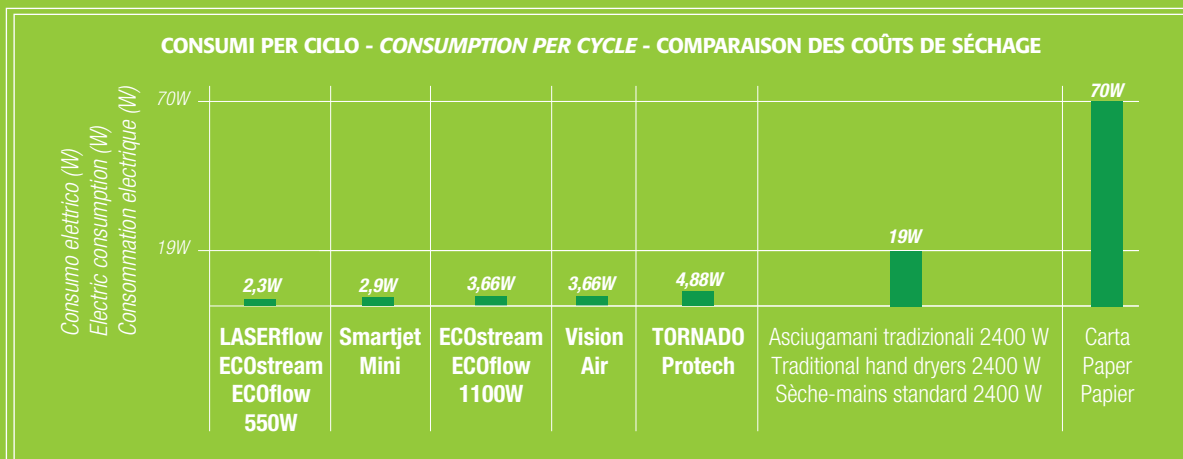





**VELOCITÀ ASCIUGATURA**  
*DRYING TIME / TEMPS DE SÉCHAGE*



**RISPARMIO ENERGETICO**  
*ENERGY SAVING / ÉPARGNE ENERGETIQUE*



**SILENZIOSITÀ**  
*NOISELESS / SILENCIEUX*



**DESIGN**



**ANTIVANDALISMO**  
*ANTIVANDALISM / ANTIVANDALISME*



# X DRY

ASCIUGAMANI - HAND DRYERS - SÈCHE-MAINS

# X Dry

X DRY

VAMA



-  - **31 VOLTE PIÙ ECONOMICO**  
RISPETTO AI ROTOLI DI COTONE
- **24 VOLTE PIÙ ECONOMICO**  
RISPETTO ALLA CARTA
- **3,5 VOLTE PIÙ ECONOMICO**  
RISPETTO AGLI ASCIUGAMANI TRADIZIONALI

-  - **31 TIMES BETTER**  
THAN COTTON DISPENSING RENT SERVICES
- **24 TIMES BETTER**  
THAN PAPER
- **3,5 TIMES BETTER**  
THAN TRADITIONAL HAND DRYERS

-  - **31 FOIS MIEUX**  
QUE LE COTON
- **24 FOIS MIEUX**  
QUE LE PAPIER
- **3,5 FOIS MIEUX**  
QUE LE SÈCHE-MAINS ÉLECTRIQUE TRADITIONNEL



**GARANZIA 3 ANNI • WARRANTY 3 YEARS • GARANTIE 3 ANS**

CE



WEEE





### ASCIUGAMANI - HAND DRYERS - SÈCHE-MAINS



- Asciugamani elettrico ECO-JET

**- Dimensioni compatte, minimo ingombro**

- Velocità aria 410 km/h

- Asciugatura super-veloce in 12/15 sec.

**- Disponibile sia con motore standard TOP-AC che con motore digitale brushless**

**- Resistenza elettrica regolabile ON-OFF per la massima efficienza energetica**

- LED per il monitoraggio del ciclo di asciugatura



- ECO-JET hand dryer

**- Compact size, it takes up in a minimal amount of space**

- Air speed 410 km/h

- Fastest drying time, 12/15 sec.

**- Available with TOP-AC motor or with brushless motor**

**- Adjustable heating element (ON-OFF)**

- Luminous LED for quick check of the drying cycle



- Seche mains ECO-JET

**- Taille compacte, encombrement minimal**

- Vitesse d'air 410 km/h

- Séchage ultra-rapide en 12/15 sec.

**- Disponible à la fois avec moteur TOP-AC standard et avec moteur brushless numérique**

**- Résistance électrique ON-OFF réglable pour une efficacité énergétique maximale**

- Lumineux à LED pour un contrôle rapide du cycle de séchage

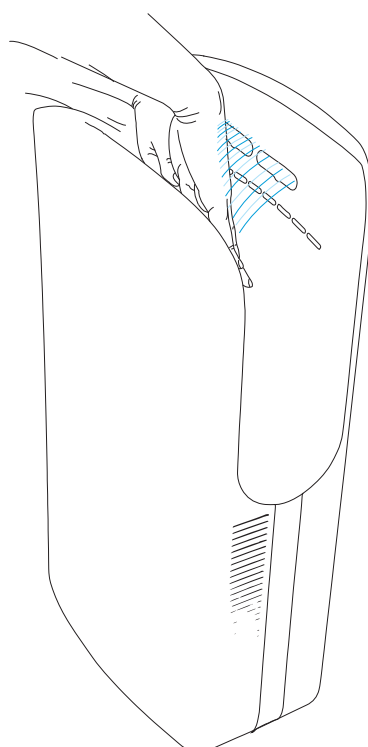

# X DRY

ASCIUGAMANI - HAND DRYERS - SÈCHE-MAINS

- ARTICOLI & CODICI PRODOTTI
- MODEL REFERENCE CHART
- TABLEAU DES MODÈLE DE RÉFÉRENCE



Cod.

X DRY BF	ABS bianco/white/blanc	Top AC
X DRY SF	ABS grigio/grey/gris	Top AC
X DRY PRO BF	ABS bianco/white/blanc	Brushless
X DRY PRO SF	ABS grigio/grey/gris	Brushless

- FILTRO EPA INCLUSO
- EPA FILTER INCLUDED
- FILTRE EPA INCLUS



Il design economico consente l'inserimento delle mani in maniera naturale. Un doppio getto di aria pulita a oltre 410 km/h avvolge le mani su entrambi i lati, consentendo un'asciugatura perfetta e l'eliminazione della sensazione di umidità, in soli 12 - 15 secondi

Natural and ergonomic designer for easy access. 410 km/h double jet air flow on both sides moves water from hands in 12 - 15 seconds

La conception ergonomique permet l'insertion des mains d'une manière naturelle. Un double jet d'air pulsé à 410 km/h entre les mains deux côtés permet un séchage parfait et élimine la sensation d'humidité, en 12 - 15 secondes.



Il motore brushless (1200 W) garantisce totale assenza di residui di carbone nel flusso d'aria; il motore TOP-AC (1250 W) il miglior prezzo

Brushless motor (1200 W) allows 100% carbon free airflow; TOP-AC motor (1200 W) the best price

Moteur brushless (1200 W) garantit l'absence totale de résidus de carbone dans le flux d'air; moteur TOP-AC (1250W) le meilleur prix



Vaschetta per la raccolta dell'acqua, al di sotto si trova il tasto ON-OFF per la gestione della resistenza elettrica

Water tank, the on-off heating element button is located below

Reservoir de collecte d'eau, ci-dessous bouton ON-OFF pour la gestion de la résistance



Il filtro EPA E11 garantisce protezione contro il 97,66% dei batteri

EPA E11 filter allows protection against 97,66% of bacteria

Le filtre EPA E11 assure une protection contre 97,66% des bactéries



- CONFRONTO COSTI DI ASCIUGATURA ANNUALI
- ANNUAL SAVINGS CALCULATION
- CALCULEZ VOS COÛTS/ECONOMIES ANNUELLES

N° UTILIZZI GIORNALIERI DAILY USE UTILISATION PAR JOUR		COTONE COTTON COTON	CARTA PAPER PAPIER	ASCIUGAMANI TRADIZIONALI 2400 W TRADITIONAL HAND DRYERS 2400 W SÈCHE-MAINS STANDARD 2400 W
100	€ 30,04 / anno	€ 949,00	€ 730,00	€ 104,04
200	€ 58,55 / anno	€ 1.898,00	€ 1.460,00	€ 205,90
400	€ 115,52 / anno	€ 3.504,00	€ 2.920,00	€ 409,65



Calcoli basati su 100 / 200 / 400 utilizzi al giorno nonché sull'utilizzo di 1 unità. Costo dell'energia di € 0,1655/kWh; costo di € 0,01 per salvietta di carta, con una media di 2 salviette per asciugatura. I costi effettivi possono variare.



Based on 100 / 200 / 400 uses per day.  
Energy cost € 0,1655/kWh; paper cost € 0,01 per sheet, with use of two sheets at once.



Calculs basés sur 100 / 200 / 400 utilisations par jour et l'utilisation de 1 unité. Coût en énergie de € 0,1655 / kWh; coût de € 0,01 pour les serviettes en papier, avec une moyenne de 2 serviettes de toilette pour le séchage. Coûts réels peuvent varier.

### CARATTERISTICHE TECNICHE / TECHNICAL FEATURES / CARACTÉRISTIQUES TECHNIQUES

Funzionamento	Sensore di rilevam. elettronico a raggi infrarossi
Functioning	Sensor operating
Activation	Capteur électronique
Giri al minuto	
Tr min	28000 rpm
Révolutions par minute	
Grado di protezione elettrica	
Electrical Protection Level	IP31 - CLASS I
Isolation électrique	
Tensione	
Supply Voltage	220 V-240 V
Tension d'alimentation	
Potenza totale	
Total power	1700 W AC Motor / 1750 W Brushless
Puissance totale	
Potenza resistenza	
Absorption Heating Element	450 W AC Motor / 550 W Brushless
Puissance chauffage	
Potenza motore	
Absorption Motor	1250 W AC Motor / 1200 W Brushless
Puissance moteur	

Dimensioni A x L x P	
Dimensions H x W x D	565 x 298 x 170 (mm)
Dimensioni H x L x P	
Frequenza	
Frequency	50-60 Hz
Fréquence	
Velocità aria	
Air Speed	410 km/h (in uscita)
Vitesse d'air	
Volume aria	
Air Flow	187 m <sup>3</sup> /h - 52 l/s,
Débit d'air	
Peso	
Weight	7,2 Kg
Poids net	
Materiale	
Materials	ABS
Matériel	
Rumorosità (2 mt)	
Noise Level (2 mt)	75 dB
Niveau de bruit (2 mt)	

ALTEZZA DI INSTALLAZIONE DA TERRA  
PUNTO DI INSERIMENTO DELLE MANI  
INSTALLATION HEIGHT FROM FLOOR  
POINT OF ENTRY OF HANDS  
HAUTEUR D'INSTALLATION DE PLANCHER  
POINT D'ENTRÉE DES MAINS



100 cm

95 cm

85 cm









# TORNADO<sup>®</sup>

## Rotech



**VELOCITÀ ASCIUGATURA**  
*DRYING TIME / TEMPS DE SÉCHAGE*



**RISPARMIO ENERGETICO**  
*ENERGY SAVING / ÉPARGNE ENERGETIQUE*



**SILENZIOSITÀ**  
*NOISELESS / SILENCIEUX*



**DESIGN**



**ANTIVANDALISMO**  
*ANTIVANDALISM / ANTIVANDALISME*



# TORNADO PROTECH

ASCIUGAMANI - HAND DRYERS - SÈCHE-MAINS

**TORNADO**<sup>®</sup>  
ROtech



-  - **31 VOLTE PIU' ECONOMICO**  
RISPETTO AI ROTOLI DI COTONE
-  - **31 TIMES BETTER**  
THAN COTTON DISPENSING RENT SERVICES
-  - **24 TIMES BETTER**  
THAN PAPER
-  - **3,5 TIMES BETTER**  
THAN TRADITIONAL HAND DRYERS
-  - **31 FOIS MIEUX**  
QUE LE COTON
-  - **24 FOIS MIEUX**  
QUE LE PAPIER
-  - **3,5 FOIS PLUS EFFICACE**  
QUE LE SÈCHE-MAINS ÉLECTRIQUE  
TRADITIONNEL



**GARANZIA 3 ANNI • WARRANTY 3 YEARS • GARANTIE 3 ANS**

CE



WEEE





- Innovativo:** Il nuovo concetto di asciugatura per gli ambienti pubblici.
- Economico:** Consente fino all'80% di risparmio rispetto agli altri sistemi di asciugatura, in particolare carta e cotone.
- Veloce ed efficace:** Asciugatura perfetta in 12-15 secondi\* attraverso un flusso d'aria ad alta velocità. (\* in funzione delle condizioni ambientali e di utilizzo).
- Igienico:** Sistema di controllo intelligente a sensori infrarossi "no touch": azionamento automatico all'inserimento delle mani, vaschetta raccolta d'acqua: nessun gocciolamento sui pavimenti, filtro EPA E11: elimina fino al 97,66% dei batteri (opzione).
- Assenza di resistenza elettrica:** riscaldamento dell'aria per compressione ed attraverso il calore dei motori, abbattendo i consumi e minimizzando i costi di manutenzione.
- New:** A new concept, an ergonomic design for hand drying.
- Economic:** Saves up to 80% costs compared to other drying systems, especially paper and cotton.
- Fast and Perfect:** Perfect drying in 12-15 seconds\* thanks to its double compressed air flow. (\* depending by environment and use condition).
- Hygienic:** Intelligent no touch infrared activating system: automatic starts when hand detected, water tank to avoid dripping and pollution on floor, EPA E11 filter: stops up to 97,66% of bacteria (option).
- No heating element:** air heating through compression and engines warming, reducing energy consumption and minimizing maintenance costs.
- Innovant:** Le nouveau concept de séchage pour les bureaux.
- Bon marché:** Permet jusqu'à 80% d'économies par rapport aux autres systèmes de séchage, notamment par rapport au papier et au coton.
- Rapidement efficace:** Séchage parfait en 12-15 secondes\* par un flux d'air à haute vitesse. (\* en fonction de l'environnement et l'utilisation).
- Hygiénique:** Système de contrôle intelligent de capteurs infrarouges "sans contact": insertion automatique du lecteur de mains, la collecte du bac de l'eau: pas de gouttes sur le sol, filtre EPA E11: élimine jusqu'à 97,66% des bactéries (option).
- Absence de résistance électrique:** chauffage de l'air grâce à la compression et à la chaleur des moteurs, ce qui réduit la consommation d'énergie et les coûts de maintenance.

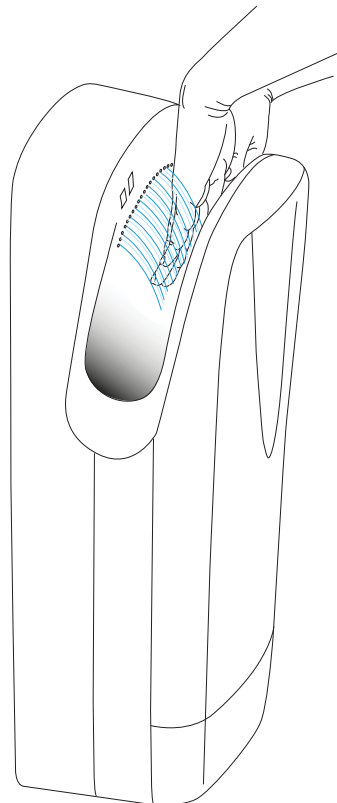

# TORNADO PROTECH ECO-JET DRYERS

ASCIUGAMANI - HAND DRYERS - SÈCHE-MAINS

- ARTICOLI & CODICI PRODOTTO**
- MODEL REFERENCE CHART**
- TABLEAU DES MODÈLE DE RÉFÉRENCE**



Cod.	
TORNADO PROtech BF	ABS Bianco / White / Blanc
TORNADO PROtech SF	ABS grigio / grey / gris

- OPZIONE FILTRO EPA E11 (TUTTI I MODELLI)**
- EPA E11 FILTER OPTION (ALL MODELS)**
- FILTRE EPA E11 EN OPTION (TOUS LES MODÈLES)**



- Il design ergonomico consente l'inserimento delle mani in maniera naturale. Un doppio getto di aria pulita a oltre 410 km/h avvolge le mani su entrambi i lati consentendo un'asciugatura perfetta e l'eliminazione della sensazione di umidità, in 12-15 secondi.
- Natural and ergonomic design for easy access. 410 km/h double jet air flow on both sides moves water from hands in 12-15 seconds.
- La conception ergonomique permet l'insertion des mains d'une manière naturelle. Un double jet d'air pulsé à 410 km/h entre les mains des deux côtés permet un séchage parfait et élimine la sensation d'humidité, en 12-15 secondes.



Le bocche a lama d'aria consentono il massimo dell'efficacia di asciugatura attraverso un gradevole massaggio



L'acqua viene canalizzata nella vaschetta di raccolta alla base dell'apparecchio, evitando il gocciolamento a terra e consentendo il massimo dell'igiene e della sicurezza



Il filtro EPA E11 garantisce protezione contro il 97,66% dei batteri\* presenti nell'aria che viene utilizzata durante l'asciugatura (opzione)

\* Certificato da **ALTI FILTER**  
Air Filter Treatment

A double compressed air flow on both sides gives hands a pleasant massage and perfect drying effect

The water tank avoids dripping on floors, pollution and bad smells. Ready and fast to empty and clean, it is warranty of maximum hygiene

EPA E11 filter allows protection against 97,66% of bacterials\*, spreading clean air on hands (option)

\* Certificate from ALTI FILTER **ALTI FILTER**  
Air Filter Treatment

Les prises d'air permettent au flux d'air de sécher avec une efficacité maximale grâce à un petit massage

L'eau est canalisée dans le bac de collecte à la base de l'appareil, en évitant les gouttes sur le sol, donnant une meilleure hygiène et une sécurité maximale

Le filtre EPA E11 assure une protection de 97,66% contre les bactéries\* contenues dans l'air au cours du séchage (option)

\* Certification ALTI FILTER **ALTI FILTER**  
Air Filter Treatment



### ASCIUGAMANI - HAND DRYERS - SÈCHE-MAINS

- CONFRONTO COSTI DI ASCIUGATURA ANNUALI
- ANNUAL SAVINGS CALCULATION
- CALCULEZ VOS COÛTS/ECONOMIES ANNUELLES

N° UTILIZZI GIORNALIERI DAILY USE UTILISATION PAR JOUR		COTONE COTTON COTON	CARTA PAPER PAPIER	ASCIUGAMANI TRADIZIONALI 2400 W TRADITIONAL HAND DRYERS 2400 W SÈCHE-MAINS STANDARD 2400 W
100	€ 30,04 / anno	€ 949,00	€ 730,00	€ 104,04
200	€ 58,55 / anno	€ 1.898,00	€ 1.460,00	€ 205,90
400	€ 115,52 / anno	€ 3.504,00	€ 2.920,00	€ 409,65



Calcoli basati su 100 / 200 / 400 utilizzi al giorno nonché sull'utilizzo di 1 unità. Costo dell'energia di € 0,1655/kWh; costo di € 0,01 per salvietta di carta, con una media di 2 salviette per asciugatura. I costi effettivi possono variare.



Based on 100 / 200 / 400 uses per day.  
Energy cost € 0,1655/kWh; paper cost € 0,01 per sheet, with use of two sheets at once.



Calculs basés sur 100 / 200 / 400 utilisations par jour et l'utilisation de 1 unité. Coût en énergie de € 0,1655 / kWh; coût de € 0,01 pour les serviettes en papier, avec une moyenne de 2 serviettes de toilette pour le séchage. Coûts réels peuvent varier.

### CARATTERISTICHE TECNICHE / TECHNICAL FEATURES / CARACTÉRISTIQUES TECHNIQUES

Funzionamento	Sensore di rilevam. elettronico a raggi infrarossi	Volume aria	2x 150 m <sup>3</sup> /h - 42 l/s,
Functioning	Sensor operating	Air Flow	
Activation	Capteur électronique	Débit d'air	
Giri al minuto		Peso	
T <sub>r</sub> min	28000 rpm	Weight	9,5 Kg
Révolutions par minute		Poids net	
Grado di protezione elettrica		Materiale	
Electrical Protection Level	IP31 - CLASS II	Materials	ABS
Isolation électrique		Matériel	
Tensione		Marchi di qualità	
Supply Voltage	220 V-240 V	Quality marks - certifications	CE
Tension d'alimentation		Certification	
Potenza totale		Rumorosità (2 mt)	
Total power	1750 W	Noise Level (2 mt)	80 dB
Puissance totale		Niveau sonore (2 mt)	
Potenza resistenza	Nessuna resistenza	Garanzia	3 anni *
Absorption Heating Element	No heating element	Warranty	3 years *
Puissance chauffage	Pas de chauffage	Garantie	3 ans *
Potenza motore			
Absorption Motor	875 W (ciascuno) / 1750 W totali		
Puissance moteur			
Dimensioni A x L x P			
Dimensions H x W x D	650 x 300 x 230 (mm)		
Dimensions H x L x P			
Frequenza			
Frequency	50-60 Hz		
Fréquence			
Velocità aria			
Air Speed	410 km/h (in uscita)		
Vitesse d'air			

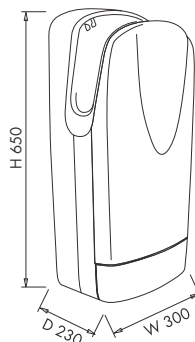

ALTEZZA DI INSTALLAZIONE DA TERRA  
PUNTO DI INSERIMENTO DELLE MANI  
INSTALLATION HEIGHT FROM FLOOR  
POINT OF ENTRY OF HANDS  
HAUTEUR D'INSTALLATION DE PLANCHER  
POINT D'ENTRÉE DES MAINS



\* Per le limitazioni di garanzia si vedano le condizioni generali di servizio

\* Limited warranty. Please have a look to the General Warranty Conditions for details and consumables

\* Limitations de garantie: voir Conditions de Garantie Generale

**vanna®**

Stream  
**DRY**  
UV

 **MADE  
IN ITALY**

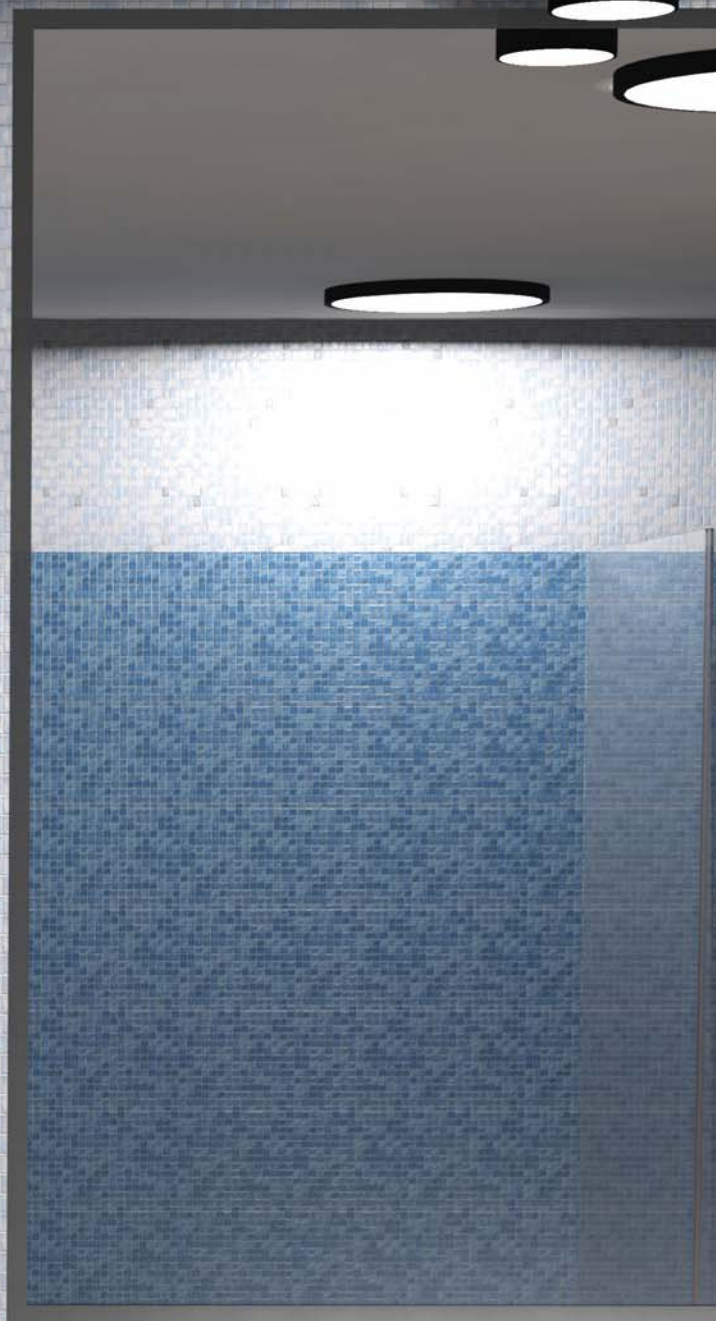

L'eccellenza **MADE IN ITALY**  
dell'asciugamani elettrico





# Stream Dry UV



**VELOCITÀ ASCIUGATURA**  
*DRYING TIME / TEMPS DE SÉCHAGE*



**RISPARMIO ENERGETICO**  
*ENERGY SAVING / ÉPARGNE ENERGETIQUE*



**SILENZIOSITÀ**  
*NOISELESS / SILENCIEUX*



**DESIGN**



**ANTIVANDALISMO**  
*ANTIVANDALISM / ANTIVANDALISME*



# STREAM DRY UV

ECO-JET DRYERS

ASCIUGAMANI - HAND DRYERS - SÈCHE-MAINS



 - **67 VOLTE PIÙ ECONOMICO**

RISPETTO AI ROTOLI DI COTONE

- **52 VOLTE PIÙ ECONOMICO**

RISPETTO ALLA CARTA

- **7 VOLTE PIÙ ECONOMICO**

RISPETTO AGLI ASCIUGAMANI TRADIZIONALI

 - **67 TIMES BETTER**

THAN COTTON DISPENSING RENT SERVICES

- **52 TIMES BETTER**

THAN PAPER

- **7 TIMES BETTER**

THAN TRADITIONAL HAND DRYERS

 - **67 FOIS MIEUX**

QUE LE COTON

- **52 FOIS MIEUX**

QUE LE PAPIER

- **7 FOIS MIEUX**

QUE LE SÈCHE-MAINS ÉLECTRIQUE TRADITIONEL





**GARANZIA 3 ANNI • WARRANTY 3 YEARS • GARANTIE 3 ANS**





# STREAM DRY UV

ASCIUGAMANI - HAND DRYERS - SÈCHE-MAINS

-  - **VELOCITÀ 300 KM/H**  
ASCIUGATURA SUPER VELOCE IN 10-15 SECONDI
  - **MOTORE TOP-AC**  
AD ALTISSIME PRESTAZIONI
  - **MASSIMO RISPARMIO ENERGETICO**  
SOLO 550 WATT (1100 WATT CON RESISTENZA, ATTIVABILE DAL GESTORE)
  - **FILTRO EPA E11**  
ASSENZA DI BATTERI E VIRUS NELL'ARIA EROGATA
  - **LAMPADA UV ANTIBATTERICA**  
SEMPRE ATTIVA PER DISINFEZIONE INTERNA
-  - **300 KM/H ULTRA FAST HAND DRYING**  
IN 10-15 SECONDS
  - **TOP-AC MOTOR**  
TOP PERFORMANCE
  - **TOP ENERGY SAVING:**  
550 WATT ONLY ( 1100 WATT WITH HEATING ELEMENT MANAGEABLE BY OWNER)
  - **EPA E 11 FILTER**  
LACK OF BACTERIES AND VIRUSES IN THE AIR
  - **UV LAMP ALWAYS ON**  
FOR INSIDE DISINFECTION
-  - **VITESSE DE L'AIR 300 KM/H**  
SECHAGE RAPIDE EN 10/15 SECONDES
  - **MOTEUR TOP-AC**  
TRÈS HAUTE PERFORMANCE
  - **ECONOMIE D'ENERGIE MAXIMALE**  
SEULMENT 550 W (1100 W AVEC RÉSISTANCE ACTIVÉ PAR LE BOUTON ON-OFF)
  - **FILTRE EPA E11**  
ABSENCE DE BACTÉRIES ET DE VIRUS DANS L'AIR FOURNI
  - **LAMPE ANTIBACTERIENNE UV**  
TOJOURS ACTIF POUR LA DÉSINFECTION INTERN

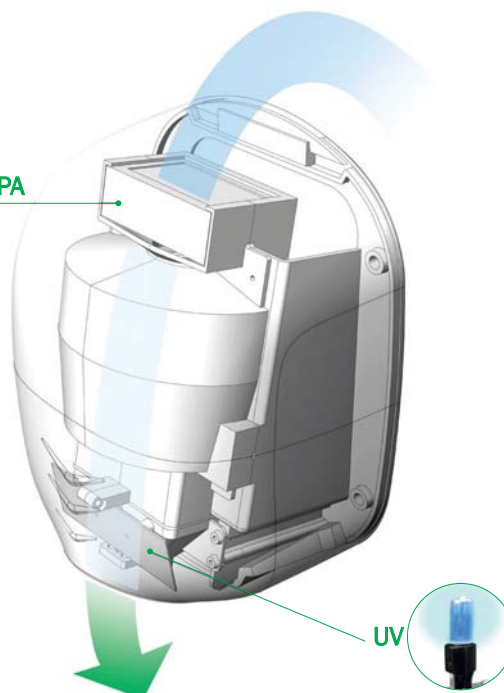

Filtro EPA / EPA filter / Filtre EPA



# STREAM DRY UV

ECO-JET DRYERS

ASCIUGAMANI - HAND DRYERS - SÈCHE-MAINS

-  **ARTICOLI & CODICI PRODOTTI**
-  **MODEL REFERENCE CHART**
-  **TABLEAU DES MODÈLE DE RÉFÉRENCE**

-  **FILTRO EPA INCLUSO**
-  **EPA FILTER INCLUDED**
-  **FILTRE EPA INCLUS**



Cod.

STREAM DRY UV ABS	Polipropilene bianco / Polypropylene white / Polypropylène blanc
STREAM DRY UV BF	Acciaio verniciato bianco / Stainless steel white / Acier blanc
STREAM DRY UV LF	Acciaio inox AISI 304 lucido / Bright AISI 304 stainless steel / Acier inox Aisi 304 brillant
STREAM DRY UV SF	Acciaio inox AISI 304 satinato / Satin AISI 304 stainless steel / Acier AISI 304 satin
STREAM DRY UV NF	Acciaio con verniciatura gofrata nera / Black metallic paint, embossed finish / Acier avec peinture métallisée noire, finition en relief



ABS



BF



SF



LF



NF



 **LAMPADA UV:** per disinfezione del condotto di ventilazione

 **UV LAMP:** for air enclosure disinfection

 **LAMPADE UV:** pour disinfection de la chambre d-air



 **FILTRO EPA E11:** garantisce protezione contro il 97,66% dei batteri

 **EPA FILTER E11:** allows protection against 97,66% of bacteria

 **FILTRE EPA E11:** assure une protection contre 97,66% des bactéries



 **RESISTENZA ON-OFF**

 **HEATING ON-OFF**

 **CHAUFFAGE ON-OFF**



# STREAM DRY UV

ASCIUGAMANI - HAND DRYERS - SÈCHE-MAINS

- 🔗 CONFRONTO COSTI DI ASCIUGATURA ANNUALI
- 🌸 ANNUAL SAVINGS CALCULATIONS
- 🔗 CALCULEZ VOS COÛTS/ECONOMIES ANNUELLES

N° UTILIZZI GIORNALIERI <i>DAILY USE</i> UTILISATION PAR JOUR	 1100 W	COTONE COTTON COTON	CARTA PAPER PAPIER	ASCIUGAMANI TRADIZIONALI 2400 W TRADITIONAL HAND DRYERS 2400 W SÈCHE-MAINS STANDARD 2400 W
100	€ 22,05/anno	€ 949,00	€ 730,00	€ 104,04
200	€ 44,10/anno	€ 1.898,00	€ 1.460,00	€ 205,91
400	€ 88,19/anno	€ 3.504,00	€ 2.920,00	€ 409,65

STREAM DRY UV

VAMA

## CARATTERISTICHE TECNICHE / TECHNICAL FEATURES / CARACTÉRISTIQUES TECHNIQUES

Funzionamento	Sensore di rilevam. elettronico a raggi infrarossi
Functioning	Sensor operating
Activation	Capteur électronique
Giri al minuto	
Tr min	26000 rpm
Révolutions par minute	
Grado di protezione elettrica	
Electrical Protection Level	IP23 - CLASS II
Isolation électrique	
Tensione	
Supply Voltage	220 V-240 V
Tension d'alimentation	
Potenza totale	
Total power	1100 W
Puissance totale	
Potenza resistenza	
Absorption Heating Element	550 W (ON-OFF)
Puissance chauffage	
Potenza motore	
Absorption Motor	550 W
Puissance moteur	
Dimensioni A x L x P	
Dimensions H x W x D	285 X 221 X 157 mm
Dimensions H x L x P	
Frequenza	
Frequency	50-60 Hz
Fréquence	
Velocità aria	
Air Speed	300 km/h
Vitesse d'air	

Volume aria	
Air Flow	187 m <sup>3</sup> /h - 52 l/s
Débit d'air	
Peso	
Weight	2,55 Kg Polipropilene - 3,05 Kg Acciaio Inox
Poids net	
Materiale	Polipropilene - Acciaio Inox AISI 304
Materials	Polipropilene - Stainless steel AISI 304
Matériel	Polipropilene - Acier Inox AISI 304
Marchi di qualità	
Quality marks - certifications	CE
Certification	
Rumorosità (2 mt)	
Noise Level (2 mt)	75 db
Niveau sonore (2 mt)	
Garanzia	3 anni*
Warranty	3 years*
Garantie	3 ans*

Accessori inclusi - Included: FILTRO EPA E11, LAMPADA UV

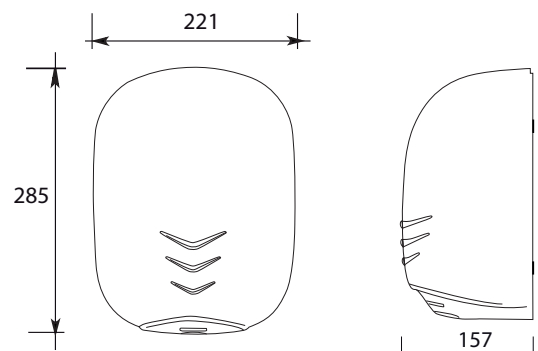

- 🔗 Per le limitazioni di garanzia si vedano le condizioni generali di servizio
- 🌸 Limited warranty. Please have a look to the General Warranty Conditions for details ans consumable
- 🔗 Limitations de garantie: revoir Conditions de Garantie Generale









**VELOCITÀ ASCIUGATURA**  
*DRYING TIME / TEMPS DE SÉCHAGE*



**RISPARMIO ENERGETICO**  
*ENERGY SAVING / ÉPARGNE ENERGETIQUE*



**SILENZIOSITÀ**  
*NOISELESS / SILENCIEUX*



**DESIGN**



**ANTIVANDALISMO**  
*ANTIVANDALISM / ANTIVANDALISME*





# EcoStream EcoFlow

ECO-JET DRYERS

ASCIUGAMANI - HAND DRYERS - SÈCHE-MAINS



-  - **67 VOLTE PIU' ECONOMICO**  
RISPETTO AI ROTOLI DI COTONE
- **52 VOLTE PIU' ECONOMICO**  
RISPETTO ALLA CARTA
- **7 VOLTE PIU' ECONOMICO**  
RISPETTO AGLI ASCIUGAMANI TRADIZIONALI

-  - **67 TIMES BETTER**  
THAN COTTON DISPENSING RENT SERVICES
- **52 TIMES BETTER**  
THAN PAPER
- **7 TIMES BETTER**  
THAN TRADITIONAL HAND DRYERS

-  - **67 FOIS MIEUX**  
QUE LE COTON
- **52 FOIS MIEUX**  
QUE LE PAPIER
- **7 FOIS PLUS EFFICACE**  
QUE LE SÈCHE-MAINS ÉLECTRIQUE TRADITIONNEL



**NUOVE VERSIONI  
NEW MODELS  
NOUVEAUX MODÈLES**



325 km/h



276 km/h

**GARANZIA 3 ANNI • WARRANTY 3 YEARS • GARANTIE 3 ANS**

**MADE  
IN ITALY**

**CE**



**WEEE**





## GUIDA ALLA SCELTA / HOW TO CHOOSE / COMMENT CHOISIR

1

🇮🇹 SCEGLI: CONO D'ARIA (EcoSTREAM) o LAMA D'ARIA (EcoFLOW)?



🇬🇧 CHOOSE: HOLE (EcoSTREAM) OR BLADE (EcoFLOW)?

🇫🇷 SELECTIONNER: CONE D'AIR (EcoSTREAM) OU LAME D'AIR (EcoFLOW)?

2

🇮🇹 SCEGLI IL MODELLO

🇬🇧 CHOOSE THE MODEL

🇫🇷 CHOISISSEZ LE MODÈLE

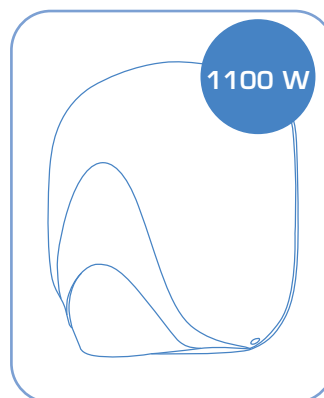
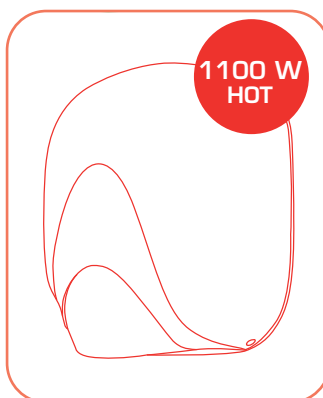
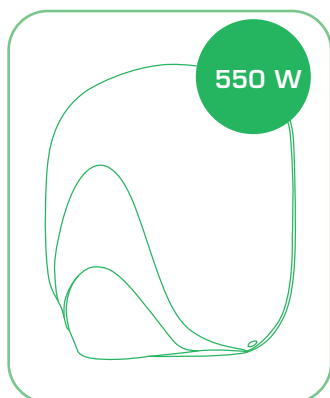

🇮🇹 ECOLOGICO: IL MAGGIOR RISPARMIO ENERGETICO

🇬🇧 GREENEST: ENERGY SAVING TOP PERFORMER

🇫🇷 ECOLOGIQUE: ECONOMIE D'ENERGIE ABSOLUE

ARIA CALDA IMMEDIATA!  
MOTORE 550 W +  
RESISTENZA 550 W

IMMEDIATELY HOT AIR!  
550 W MOTOR +  
550 W HEATING ELEMENT

AIR CHAUD IMMEDIATEMENT!  
550 W MOTEUR +  
550 W CHAUFFAGE

POTENZA ASSOLUTA:  
IL PIÙ VELOCE

POWERFUL:  
THE FASTEST ONE

PUISSANT:  
LE PLUS RAPIDE

3

🇮🇹 SCEGLI LA COVER

🇬🇧 CHOOSE YOUR FAVOURITE COVER

🇫🇷 CHOISISSEZ VOTRE COUVERTURE FAVORITE



ABS bianco, automatico  
*white ABS, sensor operating*  
ABS blanc, capteur

alluminio bianco, automatico  
*white metal, sensor operating*  
metal blanc, capteur

alluminio satinato, automatico  
*satin metal, sensor operating*  
metal satin, capteur

alluminio cromato, automatico  
*chrome metal, sensor operating*  
metal chromé, capteur



550 W - 1100 W

**TEMPO DI ASCIUGATURA: 10 - 15 sec - VELOCITA' ARIA 325 km/h (versione 1100 W)**

**IGIENE INTEGRATA**

Il filtro EPA E11 (opzione) garantisce protezione contro oltre il 97,66 % dei batteri presenti nell'aria che viene utilizzata durante l'asciugatura.

**RISPARMIO ENERGETICO ASSOLUTO: SOLO 2,3 W PER ASCIUGATURA (versione 550 W)**

- oltre 52 volte più economico rispetto alla carta (550 W)
- 85 % - 90 % di risparmio rispetto ai modelli di asciugamani tradizionali

**MOTORE STANDARD AC ALTA PRESSIONE**

**ASSENZA DI RESISTENZA ELETTRICA:** riscaldamento dell'aria per compressione ed attraverso il calore dei motori, abbattendo i consumi e minimizzando i costi manutenzione.

**DRYING TIME: 10 - 15 sec - AIR SPEED 325 km /h (1100 W version)**

**INTEGRATED HYGIENIC SYSTEM**

EPA E11 filter (option) allows protection against 97,66 % of air bacteria, spreading clean air on hands.

**ECOLOGICAL HAND DRYER, THE LOWEST POWER CONSUMPTION: ONLY 2,3 W per drying cycle (550 W version)**

- SAVE 52 times than paper (550 W)
- SAVE 85 % - 90 % than traditional hand dryers

**AC STANDARD MOTOR HIGH PRESSURE**

**NO HEATING ELEMENT:** air heating through compression and engines warming, reducing energy consumption and minimizing maintenance costs.

**TEMPS DE SÈCHAGE: 10 - 15 sec - VITESSE D'AIR 325 kilomètres par heure (Version 1100 W)**

**HYGIÈNE INTÉGRÉE**

Le filtre EPA E11 (en option) offrant une protection de plus 99.997 % des bactéries aéroportées qui est utilisée pendant le séchage.

**ÉCONOMIE D'ÉNERGIE ABSOLUE: SEULEMENT 2,3 WATT POUR LE SÈCHAGE (Version 550 W)**

- Plus de 52 fois d'économie par rapport au papier (550 W)
- 85 % - 90 % d'économie par rapport aux modèles traditionnels de sèche-mains

**STANDARD MOTEUR AC HAUTE PRESSION**

**ABSENCE DE RÉSISTANCE ÉLECTRIQUE:** chauffage de l'air grâce à la compression et à la chaleur des moteurs, ce qui réduit la consommation d'énergie et les coûts de maintenance.

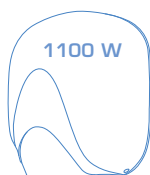

- NESSUNA RESISTENZA ELETTRICA:  
RISCALDAMENTO PROGRESSIVO CON L'UTILIZZO**
- NO HEATING ELEMENT:  
PROGRESSIVE AIR HEATING**
- ABSENCE DE RÉSISTANCE ÉLECTRIQUE:  
CHAUFFAGE AIR PROGRESSIF**



ASCIUGAMANI - HAND DRYERS - SÈCHE-MAINS



### 1100 W HOT

**MODELLI CON RESISTENZA ELETTRICA 550 W + MOTORE 550 W, TOT. 1100 W**

Perfetto equilibrio tra velocità di asciugatura / risparmio energetico / rumorosità  
Il comfort dell'aria calda fin dal primo utilizzo, con un risparmio energetico eccezionale

**MODELS WITH 550 W MOTOR + 550 W HEATING ELEMENT, TOT. 1100 W**

Perfect balance between drying speed / power saving / noise  
Immediately warm air for a more comfortable drying experience, with exceptional power saving

**MODÈLES AVEC CHAUFFAGE ELECTRIQUE 550 W + MOTEUR 550 W, TOT. 1100 W**

L'équilibre parfait entre vitesse de séchage / économie d'énergie / bruit  
Le confort de l'air chaud à partir de la première utilisation, avec économie d'énergie exceptionnelle



- ARIA CALDA IMMEDIATA!!!**
- IMMEDIATELY HOT AIR!!!**
- AIR CHAUD IMMEDIATEMENT!!!**



Il filtro EPA E11 (opzione) garantisce protezione contro il 97,66% dei batteri\* presenti nell'aria che viene utilizzata durante l'asciugatura

*EPA E11 filter (option) allows protection against 97,66% of bacteria\*, spreading clean air on hands*

Le filtre EPA E11 (en option) assure une protection de 97,66% contre les bactéries\* contenues dans l'air au cours du séchage

\* Certificato da ALTFILTER - Certificate from ALTFILTER - Certification ALTFILTER



**COVER IN ALLUMINIO CON VERNICIATURA DI COLORE NERO METALLIZZATO, FINITURA GOFRATA**



DISPONIBILE PER TUTTE LE VERSIONI 550 - 1100 - 1100 HOT

**METAL COVER, BLACK METALLIC PAINT, EMBOSSED FINISH**

AVAILABLE FOR ALL VERSIONS 550 - 1100 - 1100 HOT

**COVER EN METAL AVEC PEINTURE MÉTALLISÉE NOIRE, FINITION EN RELIEF**

DISPONIBLE POUR TOUTES LES VERSIONS 550 - 1100 - 1100 HOT

-  **ARTICOLI & CODICI PRODOTTO**
-  **MODEL REFERENCE CHART**
-  **TABLEAU DES MODÈLE DE RÉFÉRENCE**



Cod.	Mod.			Cod.	Mod.		
EST ABS 550	ECOstream	ABS Bianco / White / Blanc	550W	EFL ABS 550	ECOflow	ABS Bianco / White / Blanc	550W
EST ABS 1100	ECOstream	ABS Bianco / White / Blanc	1100W	EFL ABS 1100	ECOflow	ABS Bianco / White / Blanc	1100W
EST BF 550	ECOstream	Metallo Bianco White metal / Metal blanc	550W	EFL BF 550	ECOflow	Metallo Bianco White metal / Metal blanc	550W
EST BF 1100	ECOstream	Metallo Bianco White metal / Metal blanc	1100W	EFL BF 1100	ECOflow	Metallo Bianco White metal / Metal blanc	1100W
EST LF 550	ECOstream	Metallo Cromato Chrome metal / Metal chromé	550W	EFL LF 550	ECOflow	Metallo Cromato Chrome metal / Metal chromé	550W
EST LF 1100	ECOstream	Metallo Cromato Chrome metal / Metal chromé	1100W	EFL LF 1100	ECOflow	Metallo Cromato Chrome metal / Metal chromé	1100W
EST SF 550	ECOstream	Metallo Satinato Satin metal / Metal satin	550W	EFL SF 550	ECOflow	Metallo Satinato Satin metal / Metal satin	550W
EST SF 1100	ECOstream	Metallo Satinato Satin metal / Metal satin	1100W	EFL SF 1100	ECOflow	Metallo Satinato Satin metal / Metal satin	1100W



Cod.	Mod.			Cod.	Mod.		
EST ABS 1100 HOT	ECOstream	ABS Bianco / White / Blanc	1100W	EFL ABS 1100 HOT	ECOflow	ABS Bianco / White / Blanc	1100W
EST BF 1100 HOT	ECOstream	Metallo Bianco White metal / Metal blanc	1100W	EFL BF 1100 HOT	ECOflow	Metallo Bianco White metal / Metal blanc	1100W
EST LF 1100 HOT	ECOstream	Metallo Cromato Chrome metal / Metal chromé	1100W	EFL LF 1100 HOT	ECOflow	Metallo Cromato Chrome metal / Metal chromé	1100W
EST SF 1100 HOT	ECOstream	Metallo Satinato Satin metal / Metal satin	1100W	EFL SF 1100 HOT	ECOflow	Metallo Satinato Satin metal / Metal satin	1100W



**OPZIONE FILTRO EPA E11 (TUTTI I MODELLI)**  
**EPA E11 FILTER OPTION (ALL MODELS)**  
**FILTRE EPA E11 EN OPTION (TOUS LES MODÈLES)**



### ASCIUGAMANI - HAND DRYERS - SÈCHE-MAINS

- CONFRONTO COSTI DI ASCIUGATURA ANNUALI
- ANNUAL SAVINGS CALCULATION
- CALCULEZ VOS COÛTS/ECONOMIES ANNUELLES

N° UTILIZZI GIORNALIERI DAILY USE UTILISATION PAR JOUR	ECOSTREAM ECOFLOW 1100W	ECOSTREAM ECOFLOW 550W	VAMA TORNADO PROTECH®	COTONE COTTON COTON	CARTA PAPER PAPIER	ASCIUGAMANI TRADIZIONALI 2400 W TRADITIONAL HAND DRYERS 2400 W SÈCHE-MAINS STANDARD 2400 W
100	€ 22,05/anno	€ 13,89/anno	€ 30,04	€ 949,00	€ 730,00	€ 104,04
200	€ 44,10/anno	€ 27,79/anno	€ 58,55	€ 1.898,00	€ 1.460,00	€ 205,91
400	€ 88,19/anno	€ 55,57/anno	€ 115,52	€ 3.504,00	€ 2.920,00	€ 409,65



Calcoli basati su 100 / 200 / 400 utilizzi al giorno nonché sull'utilizzo di 1 unità. Costo dell'energia di € 0,1655/kWh; costo di € 0,01 per salvietta di carta, con una media di 2 salviette per asciugatura. I costi effettivi possono variare.



Based on 100 / 200 / 400 uses per day. Energy cost € 0,1655/kWh; paper cost € 0,01 per sheet, with use of two sheets at once.



Calculs basés sur 100 / 200 / 400 utilisations par jour et l'utilisation de 1 unité. Coût en énergie de € 0,1655 / kWh; coût de € 0,01 pour les serviettes en papier, avec une moyenne de 2 serviettes de toilette pour le séchage. Coûts réels peuvent varier.

#### CARATTERISTICHE TECNICHE / TECHNICAL FEATURES / CARACTÉRISTIQUES TECHNIQUES

Funzionamento	Sensore di rilevam. elettronico a raggi infrarossi	Volume aria	
Functioning	Sensor operating	Air Flow	187 m <sup>3</sup> /h - 52 l/s (1100 W), 126 m <sup>3</sup> /h - 35 l/s (550 W)
Activation	Capteur électronique	Débit d'air	
Ciri al minuto		Peso	
Tr min	30000 rpm (1100 W) - 26000 rpm (550 W)	Weight	5,00 Kg (Metallo) - 3,00 Kg (ABS)
Révolutions par minute		Poids net	
Grado di protezione elettrica		Materiale	ABS - Alluminio pressofuso
Electrical Protection Level	IP23 - CLASS II	Materials	ABS - Die Cast Aluminium
Isolation électrique		Matériel	ABS - en fonte d'aluminium
Tensione		Marchi di qualità	
Supply Voltage	220 V-240 V	Quality marks - certifications	CE
Tension d'alimentation		Certification	
Potenza totale		Rumorosità (2 mt)	
Total power	1100 W - 550 W	Noise Level (2 mt)	80 db (1100 W) 75 db (550 W)
Puissance totale		Niveau sonore (2 mt)	
Potenza resistenza		Garanzia	3 anni*
Absorption Heating Element	550 W (solo - only - seule mod. HOT)	Warranty	3 years*
Puissance chauffage		Garantie	3 ans*
Potenza motore			
Absorption Motor	1100 W - 550 W		
Puissance moteur			
Dimensioni A x L x P			
Dimensions H x W x D	285 X 221 X 157 mm		
Dimensions H x L x P			
Frequenza			
Frequency	50-60 Hz		
Fréquence			
Velocità aria			
Air Speed	325 km/h (1100 W) - 250 km/h (550 W)		
Vitesse d'air			

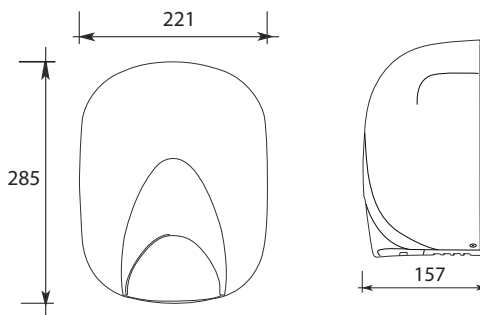

\* Per le limitazioni di garanzia si vedano le condizioni generali di servizio

\* Limited warranty. Please have a look to the General Warranty Conditions for details and consumables

\* Limitations de garantie: revoir Conditions de Garantie Generale





# smart jet

mini



**VELOCITÀ ASCIUGATURA**  
*DRYING TIME / TEMPS DE SÉCHAGE*



**RISPARMIO ENERGETICO**  
*ENERGY SAVING / ÉPARGNE ENERGETIQUE*



**SILENZIOSITÀ**  
*NOISELESS / SILENCIEUX*



**DESIGN**



**ANTIVANDALISMO**  
*ANTIVANDALISM / ANTIVANDALISME*



## smart jet mini



-  - **52 VOLTE PIU' ECONOMICO**  
RISPETTO AI ROTOLI DI COTONE
- **40 VOLTE PIU' ECONOMICO**  
RISPETTO ALLA CARTA
- **6 VOLTE PIU' ECONOMICO**  
RISPETTO AGLI ASCIUGAMANI TRADIZIONALI
-  - **52 TIMES BETTER**  
THAN COTTON DISPENSING RENT SERVICES
- **40 TIMES BETTER**  
THAN PAPER
- **6 TIMES BETTER**  
THAN TRADITIONAL HAND DRYERS
-  - **52 FOIS MIEUX**  
QUE LE COTON
- **40 FOIS MIEUX**  
QUE LE PAPIER
- **6 FOIS PLUS EFFICACE**  
QUE LE SÈCHE-MAINS ÉLECTRIQUE TRADITIONNEL



**GARANZIA 3 ANNI • WARRANTY 3 YEARS • GARANTIE 3 ANS**



WEEE





### ASCIUGAMANI - HAND DRYERS - SÈCHE-MAINS

**IL PIÙ PICCOLO ECO-JET DRYER AL MONDO: PROFONDITÀ INFERIORE A 10 CM!!!**  
**GARANTISCE UN'ASCIUGATURA ULTRA RAPIDA CONSENTENDO UN ENORME RISPARMIO ENERGETICO:**

- Velocità aria 200 km/h, asciuga in 20 sec., potenza soli 900 W
- Ottimo rapporto performance / consumi / budget di spesa
- DESIGN DI ULTIMA GENERAZIONE: versioni in ABS bianco, cromo-satinato, cromato
- Funzionamento automatico con distanza di induzione regolabile
- FILTRO EPA E11 (opzionale): garantisce protezione contro oltre il 97,66% dei batteri presenti nell'aria che viene utilizzata durante l'asciugatura.



**THE SMALLEST EXISTING ECO-JET DRYER: DEPTH LOWER THAN 10 CM!!!**  
**SHORT DRYING TIME, HUGE ENERGY SAVING:**

- 200 km/h air speed, 20 sec. drying time, only 900 W!
- Optimum performance / consumption / budget ratio
- ATTRACTIVE DESIGN: white, chrome-satin, chrome ABS cover
- Sensor operated, with adjustable distance detection
- EPA E11 FILTER (option): it allows protection against 97,66% of bacterials, spreading clean air on hands



**LE PLUS PETIT SECHOIR-ECO-JET DANS LE MONDE:**  
**PROFONDEUR INFÉRIEURE À 10 CM!!!**  
**ASSURE UN SÉCHAGE SUPER RAPIDE EN PERMETTANT D'ÉNORMES ÉCONOMIES D'ÉNERGIE:**

- Vitesse d'air 200 km/h, temp de séchage 20 secondes, seulement 900 W de puissance!
- Excellente performance / consommation / budget
- DERNIERE GENERATION, DESIGN ET CONCEPTION: disponible dans les versions ABS blanc, chromé-brossé, chromé
- Fonctionnement automatique avec distance d'induction réglable
- FILTRE EPA E11 (option): assure une protection de 97,66% contre les bactéries contenues dans l'air au cours du séchage.



Il filtro EPA E11 (opzione) garantisce protezione contro il 97,66% dei batteri\* presenti nell'aria che viene utilizzata durante l'asciugatura

*EPA E11 filter (option) allows protection against 97,66% of bacterials\*, spreading clean air on hands*

Le filtre EPA E11 en option) assure une protection de 97,66% contre les bactéries\* contenues dans l'air au cours du séchage

\* Certificato da ALTFILTER - Certificate from ALTFILTER - Certification ALTFILTER



#### SMART JET MINI / BF

- ABS bianco, automatico
- white ABS, sensor operating
- ABS blanc, capteur



#### SMART JET MINI / SF

- ABS cromo-satinato, automatico
- chrome-satin ABS, sensor operating
- ABS chromé brossé, capteur



#### SMART JET MINI / LF

- ABS cromato, automatico
- chrome ABS, sensor operating
- ABS chromé, capteur

- 🇮🇹 **CONFRONTO COSTI DI ASCIUGATURA ANNUALI**
- 🇬🇧 **ANNUAL SAVINGS CALCULATION**
- 🇫🇷 **CALCULEZ VOS COÛTS/ECONOMIES ANNUELLES**

N° UTILIZZI GIORNALIERI DAILY USE UTILISATION PAR JOUR		COTONE COTTON COTON	CARTA PAPER PAPIER	ASCIUGAMANI TRADIZIONALI 2400 W TRADITIONAL HAND DRYERS 2400 W SÈCHE-MAINS STANDARD 2400 W
100	<b>€ 18,08 / anno</b>	€ 949,00	€ 730,00	€ 104,04
200	<b>€ 36,16 / anno</b>	€ 1.898,00	€ 1.460,00	€ 205,91
400	<b>€ 72,31 / anno</b>	€ 3.504,00	€ 2.920,00	€ 409,65



Calcoli basati su 100/200/400 utilizzi al giorno nonché sull'utilizzo di 1 unità. Costo dell'energia di € 0,1655/kWh; costo di € 0,01 per salvietta di carta, con una media di 2 salviette per asciugatura. I costi effettivi possono variare.



*Based on 100 / 200 / 400 uses per day.  
Energy cost € 0,1655/kWh; paper cost € 0,01 per sheet, with use of two sheets at once.*



Calculs basés sur 100 / 200 / 400 utilisations par jour et l'utilisation de 1 unité. Coût en énergie de € 0,1655 / kWh; coût de € 0,01 pour les serviettes en papier, avec une moyenne de 2 serviettes de toilette pour le séchage. Coûts réels peuvent varier.

#### CARATTERISTICHE TECNICHE / TECHNICAL FEATURES / CARACTÉRISTIQUES TECHNIQUES

Funzionamento	Sensore di rilevam. elettronico a raggi infrarossi
Functioning	Sensor operating
Activation	Capteur électronique
Giri al minuto	
Tr min	28000 rpm
Révolutions par minute	
Grado di protezione elettrica	
Electrical Protection Level	IP23 - CLASS II
Isolation électrique	
Tensione	
Supply Voltage	220 V-240 V
Tension d'alimentation	
Volume aria	
Air Flow	110 m <sup>3</sup> /h - 31 l/s
Débit d'air	
Potenza totale	
Total power	900 W
Puissance totale	
Potenza resistenza	
Absorption Heating Element	500 W
Puissance chauffage	
Potenza motore	
Absorption Motor	400 W
Puissance moteur	
Dimensioni A x L x P	
Dimensions H x W x D	238 x 156 x 99,5 (mm)
Dimensions H x L x P	
Frequenza	
Frequency	50-60 Hz
Fréquence	

Velocità aria	
Air Speed	200 km/h
Vitesse d'air	
Peso	
Weight	1,2 Kg
Poids net	
Materiale	
Materials	ABS
Matériel	
Marchi di qualità	
Quality marks - certifications	CE RoHs WEEE
Certification	
Rumorosità (2 mt)	
Noise Level (2 mt)	80 dB
Niveau sonore (2 mt)	
Garanzia	3 anni *
Warranty	3 years *
Garantie	3 ans *

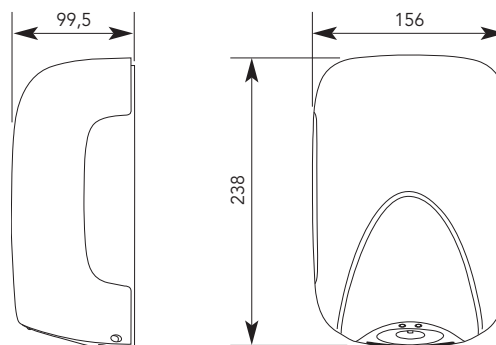

- 🇮🇹 \* Per le limitazioni di garanzia si vedano le condizioni generali di servizio
- 🇬🇧 \* Limited warranty. Please have a look to the General Warranty Conditions for details and consumables
- 🇫🇷 \* Limitations de garantie: revoir Conditions de Garantie Generale



**LASER**  
**FLOW**



**THE BRUSHLESS  
EXPERIENCE**



# LASER FLOW

- 
**- VELOCITÀ 400 KM/H:**  
 ASCIUGATURA SUPER VELOCE IN 10-15 SECONDI
  - MOTORE BRUSHLESS O TOP-AC**  
 AD ALTISSIME PRESTAZIONI
  - MASSIMO RISPARMIO ENERGETICO:**  
 SOLO 900 WATT (1450 WATT CON RESISTENZA, ATTIVABILE DAL GESTORE)
  - DOPPIO FILTRO EPA E11**  
 ASSENZA DI BATTERI E VIRUS NELL'ARIA EROGATA
  - LAMPADA UV ANTIBATTERICA**  
 SEMPRE ATTIVA PER DISINFEZIONE INTERNA
- 
**- 400 KM/H ULTRA FAST HAND DRYING**  
 IN 10-15 SECONDS
  - BRUSHLESS OR TOP-AC MOTOR**  
 TOP PERFORMANCE
  - TOP ENERGY SAVING:**  
 900 WATT ONLY (1450 WATT WITH HEATING ELEMENT MANAGEABLE BY OWNER)
  - DOUBLE EPA E11 FILTER**  
 LACK OF BACTERIES AND VIRUSES IN THE AIR
  - UV LAMP ALWAYS ON**  
 FOR INSIDE DISINFECTION
- 
**- 400 KM/H: SECHAGE ULTRA RAPIDE**  
 EN 10-15 SECONDES
  - MOTEUR BRUSHLESS OU TOP-AC**  
 PERFORMANCE MAXIMIZÉ
  - EPARGNE ENERGETIQUE MAXIMIZÉ:**  
 SEULE 900WATT (1450 WATT AVEC RESISTANCE ACTIVABLE PAR LE GÉRANT)
  - DOUBLE FILTRE EPA E11**
  - LAMPE UV TOUJOURS ACTIV POUR DÉSINFECTION INTERNE**



**GARANZIA 3 ANNI • WARRANTY 3 YEARS • GARANTIE 3 ANS**



## GUIDA ALLA SCELTA / HOW TO CHOOSE / COMMENT CHOISIR

1

**SCEGLI: MOTORE BRUSHLESS o MOTORE TOP-AC, 900WATT**



**CHOOSE: BRUSHLESS OR TOP-AC MOTOR 900WATT**

**SELECTIONNER: MOTEUR BRUSHLESS OU TOP-AC 900 WATT**

2

**SCEGLI IL MODELLO**

**CHOOSE THE MODEL**

**CHOISISSEZ LE MODÈLE**

**LASERFLOW**



BIANCO



GRIGIO

**ECOLOGICO: FILTRI EPA E11 E LAMPADA UV SEMPRE ATTIVI**

**ECOLOGICAL AND HEALTHY: EPA E11 FILTERS AND UV LAMP ALWAYS ON**

**ECOLOGIQUE ET HYGIENIQUE: FILTRE EPA E11 ET LAMPADE UV TOUJOURS ACTIVE**

**ARIA CALDA IMMEDIATA! MOTORE 900 W + RESISTENZA 550 W**

**IMMEDIATELY HOT AIR! 900 W MOTOR + 550 W HEATING ELEMENT**

**AIR CHAUD IMMEDIATEMENT! 900 W MOTEUR + 550 W CHAUFFAGE**

**POTENZA ASSOLUTA: 400 KM/H: IL PIÙ VELOCE**

**POWERFUL: 400 KM/H: THE FASTEST ONE**

**PUISSANT: 400 KM/H: LE PLUS RAPIDE**

3

**ATTIVA LA RESISTENZA IN CASO DI TEMPERATURE RIGIDE O SCARSO UTILIZZO; DISATTIVALA SE L'USO È FREQUENTE: IL MOTORE MANTERRÀ SEMPRE L'ARIA CALDA SENZA BISOGNO DELLA RESISTENZA**

**ACTIVATE THE HEATING ELEMENT IN CASE OF LOW TEMPERATURES OR RARE USE; TURN IT OFF IF FREQUENTLY USED: ENGINE WILL KEEP ALWAYS HOT AIR WITHOUT NEED OF RESISTANCE**

**VOUS POUVEZ ACTIVER LA RESISTANCE EN CAS DE BASSE TEMPÉRATURE OU UTILISATION RARE; ÉTEIGNEZ-LA SI L'UTILISATION EST FREQUENT: LE MOTEUR GARDERA L'AIR CHAUD TOUJOURS SANS BESOIN DE RÉSISTANCE**



#### **TEMPO DI ASCIUGATURA: 10 - 15 sec – VELOCITA' ARIA 400 km/h**

##### **MASSIMA IGIENE INTEGRATA - DOPPIO LIVELLO DI PROTEZIONE ANTIBATTERICA**

Il doppio filtro EPA E11 garantisce protezione contro oltre il 97,66 % dei batteri presenti nell'aria che viene utilizzata durante l'asciugatura. La lampada UV, sempre attiva, disinfetta il condotto dell'aria uccidendo virus e batteri presenti

##### **RISPARMIO ENERGETICO ASSOLUTO: SOLO 900 WATT DI POTENZA OSSIA 2,3 W PER ASCIUGATURA (CON RESISTENZA SPENTA)**

- oltre 50 volte più economico rispetto alla carta
- 85 % - 90 % di risparmio rispetto ai modelli di asciugamani tradizionali

##### **MOTORE BRUSHLESS AD ALTA DURATA, PER UNA COMPLETA ASSENZA DI RESIDUI DI CARBONE, GARANZIA DI MASSIMA IGIENE E SICUREZZA IN AMBIENTI OSPEDALIERI E INDUSTRIE ALIMENTARI**

IN ALTERNATIVA MOTORE STANDARD TOP-AC NELLA VERSIONE BASIC

**RESISTENZA ELETTRICA DISATTIVABILE** DAL GESTORE PER MINIMIZZARE I CONSUMI ELETTRICI IN AMBIENTI AD ALTA AFFLUENZA

#### **DRYING TIME: 10 - 15 sec – AIR SPEED 400 km /h**

##### **INTEGRATED HYGIENIC SYSTEM DOUBLE LEVEL ANTIBACTERIAL PROTECTION**

Double EPA E11 filter allows protection against 97,66 % of air bacteria, spreading clean air on hands. UV lamp always on, kills bacteria and viruses in the air cone

##### **ECOLOGICAL HAND DRYER, THE LOWEST POWER CONSUMPTION: ONLY 900 WATT TOTAL POWER. 2,3 WATT per drying cycle - (heating element OFF)**

- SAVE 50 times than paper
- SAVE 85 % - 90 % than traditional hand dryers

##### **BRUSHLESS MOTOR FOR TOTAL CARBON FREE FEATURE, BEST SOLUTION IN HOSPITAL AND HEALTH CARE ENVIRONMENTS, FOOD INDUSTRY**

TOP-AC STANDARD MOTOR HIGH PRESSURE FOR BASIC CHEAPER VERSION

**HEATING ELEMENT:** HEATING ELEMENT TO BE ACTIVATED OR NOT BY OWNER

#### **TEMPS DE SÈCHAGE: 10 - 15 sec – VITESSE D'AIR 400 kilomètres par heure**

##### **HYGIÈNE INTÉGRÉE A DEUX NIVEAUX**

Le 2 filtres EPA E11 offrant une protection de plus 99.997 % des bactéries aéroportées qui est utilisée pendant le séchage. La LAMPE UV élimine les virus ou les bactéries présent dans le conduit d'air

##### **ÉCONOMIE D'ÉNERGIE ABSOLUE: SEULEMENT 900 Watt, 2,3 WATT POUR CHAQUE SÈCHAGE**

- Plus de 50 fois d'économie par rapport au papier
- 85 % - 90 % d'économie par rapport aux modèles traditionnels de sèche-mains

##### **MOTEUR BRUSHLESS POUR UNE TOTALE ABSENCE DE POUVRE DE CARBON DANS L'AIRE, IDÉALE POUR HOSPITALES ET AMBIENT SENSIBLE, INDUSTRIES ALIMENTAIRES**

MOTOEUR TOP-AC POUR UNE VERSIONE MOIN CHER

**RÉSISTANCE ÉLECTRIQUE:** ELEMENT DE CHAUFFAGE DE L'AIR ACTIVABLE OU NON PAR LE GERANT





-  **ARTICOLI & CODICI PRODOTTO**
-  **MODEL REFERENCE CHART**
-  **TABLEAU DES MODÈLE DE RÉFÉRENCE**

# LASERFLOW



Cod.	Mod.	Colore	Motore 900 WATT	Resistenza 550 WATT	UV LAMP
UV PRO BF	LASERFLOW	ABS Bianco / White / Blanc	BRUSHLESS	ON-OFF	ON-OFF
UV PRO SF	LASERFLOW	ABS Grigio / Grey / Gris	BRUSHLESS	ON-OFF	ON-OFF
UV BASIC BF	LASERFLOW	ABS Bianco / White / Blanc	TOP-AC	ON-OFF	ON-OFF
UV BASIC SF	LASERFLOW	ABS Grigio / Grey / Gris	TOP-AC	ON-OFF	ON-OFF

-  **NELLE VERSIONI PRO IL PANNELLO SUPERIORE LUMINOSO A LED INDICA LO STATO DELLA MACCHINA, DELLA RESISTENZA E DELLA LAMPADA UV**
-  **PRO VERSION ONLY HAS LED PANEL SHOWING DRYER STATUS, HEATING AND UV LAMP ON OR OFF**
-  **DANS LA VERSION PRO UN PANEAU LED INDIQUE L'ÉTAT DE L'APPAREIL, DE LA RESISTANCE ET DE LA LAMPADA UV**

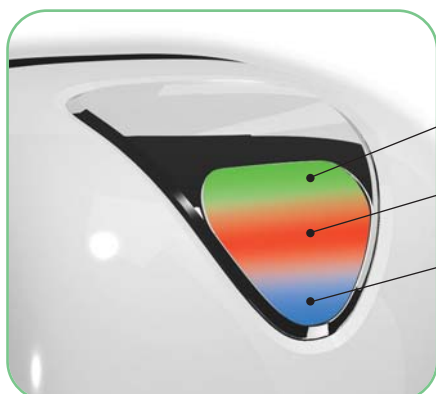

LED ON: DRYER ON

LED ON: RESISTENZA ON  
(HEATING-RESISTANCE ON)

LED ON: UV LAMP ON



 **MODELLI CON RESISTENZA ELETTRICA 550 W DISATTIVABILE + MOTORE 900 W**

BASSA rumorosità CON PRESTAZIONI JET, SOLO 75 Db a 2 metri di distanza  
Il comfort dell'aria calda fin dal primo utilizzo, con un risparmio energetico eccezionale



 **MODELS WITH 900 W MOTOR + 550 W ON-OFF HEATING ELEMENT**

Immediately warm air for a more comfortable drying experience, with exceptional power saving. LOW NOISE, only 75 dB at 2 mt. distance



 **MODÈLES AVEC CHAUFFAGE ELECTRIQUE 550 W DISACTIVABLE + MOTEUR 900W**

Le confort de l'air chaud à partir de la première utilisation, avec économie d'énergie exceptionnelle et BAS BRUIT (75 Db a 2 mt.)



LAMPADA UV DA 3 WATT PER DISINFEZIONE DEL CONDOTTO DI VENTILAZIONE  
UV LAMP 3 WATT FOR AIR ENCLOSURE DISINFECTION  
LAMPADÉ UV POUR DISINFECTION DE LA CHAMBRE D'AIR



 **ARIA CALDA IMMEDIATA!!!**  
 **IMMEDIATELY HOT AIR!!!**  
 **AIR CHAUD IMMEDIATEMENT!!!**



Il filtro EPA E11 garantisce protezione contro il 97,66% dei batteri\* presenti nell'aria che viene utilizzata durante l'asciugatura

*EPA E11 filter allows protection against 97,66% of bacteria\*, spreading clean air on hands*

Le filtre EPA E11 assure une protection de 97,66% contre les bactéries\* contenues dans l'air au cours du séchage

\* Certificato da ALTFILTER - Certificate from ALTFILTER - Certification ALTFILTER



## THE BRUSHLESS EXPERIENCE 100% GREEN

-  100% MOTORE DIGITALE
-  100% DIGITAL MOTOR
-  100% MOTEUR DIGITALE
-  100% LIBERO DA EMISSIONE DI CARBONIO NELL'AMBIENTE
-  100% CARBON FREE
-  100% SANS CARBON



### ASCIUGAMANI - HAND DRYERS - SÈCHE-MAINS

- CONFRONTO COSTI DI ASCIUGATURA ANNUALI
- ANNUAL SAVINGS CALCULATION
- CALCULEZ VOS COÛTS/ECONOMIES ANNUELLES

N° UTILIZZI GIORNALIERI DAILY USE UTILISATION PAR JOUR	LASERFLOW 900W	ECOSTREAM ECOFLOW 1100W	VAMA TORNADO PROTECH®	COTONE COTTON COTON	CARTA PAPER PAPIER	ASCIUGAMANI TRADIZIONALI 2400 W TRADITIONAL HAND DRYERS 2400 W SÈCHE-MAINS STANDARD 2400 W
100	€ 18,08/anno	€ 22,05	€ 30,04	€ 949,00	€ 730,00	€ 104,04
200	€ 36,16/anno	€ 44,10	€ 58,55	€ 1.898,00	€ 1.460,00	€ 205,91
400	€ 72,31/anno	€ 88,19	€ 115,52	€ 3.504,00	€ 2.920,00	€ 409,65



Calcoli basati su 100 / 200 / 400 utilizzi al giorno nonché sull'utilizzo di 1 unità. Costo dell'energia di € 0,1655/kWh; costo di € 0,01 per salvietta di carta, con una media di 2 salviette per asciugatura. I costi effettivi posso variare.



Based on 100 / 200 / 400 uses per day. Energy cost € 0,1655/kWh; paper cost € 0,01 per sheet, with use of two sheets at once.



Calculs basés sur 100 / 200 / 400 utilisations par jour et l'utilisation de 1 unité. Coût en énergie de € 0,1655 / kWh; coût de € 0,01 pour les serviettes en papier, avec une moyenne de 2 serviettes de toilette pour le séchage. Coûts réels peuvent varier.

#### CARATTERISTICHE TECNICHE / TECHNICAL FEATURES / CARACTÉRISTIQUES TECHNIQUES

Funzionamento	Sensore di rilevam. elettronico a raggi infrarossi	Volume aria	
Functioning	Sensor operating	Air Flow	250 m³/h - 75 l/s
Activation	Capteur électronique	Débit d'air	
Giri al minuto		Peso	
Tr min	26000 rpm	Weight	5,00 Kg
Révolutions par minute		Poids net	
Grado di protezione elettrica		Materiale	
Electrical Protection Level	IP34 - CLASS II	Materials	ABS - Nylon
Isolation électrique		Matériel	
Tensione		Marchi di qualità	
Supply Voltage	220 V-240 V	Quality marks - certifications	CE
Tension d'alimentation		Certification	
Potenza totale		Rumorosità (2 mt)	
Total power	900 W - 1450 W	Noise Level (2 mt)	75 db
Puissance totale		Niveau sonore (2 mt)	
Potenza resistenza		Garanzia	3 anni*
Absorption Heating Element	550 W	Warranty	3 years*
Puissance chauffage		Garantie	3 ans*
Potenza motore	Brushless \ Top AC		
Absorption Motor	900 W		
Puissance moteur			
Dimensioni A x L x P			
Dimensions H x W x D	348 X 256 X 185 mm		
Dimensions H x L x P			
Frequenza			
Frequency	50-60 Hz		
Fréquence			
Velocità aria			
Air Speed	400 km/h		
Vitesse d'air			

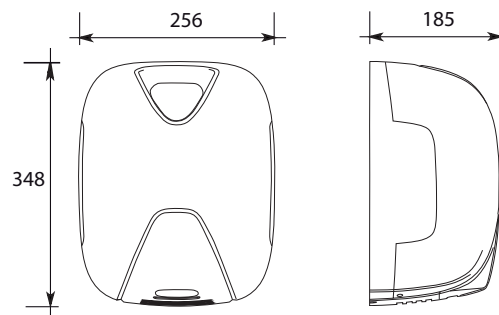

\* Per le limitazioni di garanzia si vedano le condizioni generali di servizio

\* Limited warranty. Please have a look to the General Warranty Conditions for details and consumables

\* Limitations de garantie: revoir Conditions de Garantie Generale

# VISIONair



**VELOCITÀ ASCIUGATURA**  
*DRYING TIME / TEMPS DE SÉCHAGE*



**RISPARMIO ENERGETICO**  
*ENERGY SAVING / ÉPARGNE ENERGETIQUE*



**SILENZIOSITÀ**  
*NOISELESS / SILENCIEUX*



**DESIGN**



**ANTIVANDALISMO**  
*ANTIVANDALISM / ANTIVANDALISME*





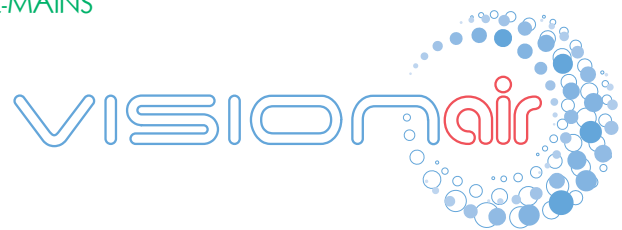

-  - **43 VOLTE PIU' ECONOMICO**  
RISPETTO AI ROTOLI DI COTONE
- **33 VOLTE PIU' ECONOMICO**  
RISPETTO ALLA CARTA
- **5 VOLTE PIU' ECONOMICO**  
RISPETTO AGLI ASCIUGAMANI TRADIZIONALI
-  - **43 TIMES BETTER**  
THAN COTTON DISPENSING RENT SERVICES
- **33 TIMES BETTER**  
THAN PAPER
- **5 TIMES BETTER**  
THAN TRADITIONAL HAND DRYERS
-  - **43 FOIS MIEUX**  
QUE LE COTON
- **33 FOIS MIEUX**  
QUE LE PAPIER
- **5 FOIS PLUS EFFICACE**  
QUE LE SÈCHE-MAINS ÉLECTRIQUE TRADITIONNEL



**GARANZIA 3 ANNI • WARRANTY 3 YEARS • GARANTIE 3 ANS**



 **Facilità & ergonomia:** modalità di utilizzo con inserimento delle mani in orizzontale, che abbina l'ergonomia alla facilità d'utilizzo per tutte le fasce d'utenza.

**Meno consumi... super velocità & risparmio energetico estremo:** ottimizzazione dei flussi d'aria grazie al sistema circolare a 4 lame: velocità 425 Km/h ed asciugatura in 10-12 secondi. Potenza tot. pari a soli 1100 W ed **assenza di resistenza** estremizzano il risparmio energetico, consentendo un risparmio di oltre il 95% rispetto agli altri sistemi di asciugatura.

**Progettazione customer oriented:** sviluppato e progettato in base allo studio delle esigenze dei clienti e rispetto ai "talloni d'Achille" dei modelli esistenti. Il doppio sensore di avvio e i sensori luminosi di avviso (vaschetta piena/spazzole motori esaurite/pulizia filtro EPA E11) consentono un agevole monitoraggio del ciclo di vita del prodotto e minimizzano le necessità di assistenza tecnica, in particolare le urgenze dovute a una mancata manutenzione-monitoraggio da parte del cliente finale.

**Igiene integrata:** protezione antibatterica e dell'ambiente d'uso, garantita dal filtro EPA E11 contro il 97,66% dei batteri presenti nell'aria e dalla raccolta dell'acqua residua nella vaschetta, senza più scolo a terra.

**Progettare il futuro:** design contemporaneo & Made in Italy.

 **Easy & ergonomics:** use it with insertion of hands horizontally, which combines ergonomics with accessibility for all user categories.

**Less consumption... super speed & extreme energy savings:** optimization of air flow through a system of 4 circular air blades: speed 425 Km / hand drying in 10-12 seconds. Total power of only 1100 W, with **absence of heating element** to maximize power energy savings, for over 95 % compared to other drying systems.

**Design customer-oriented:** developed and designed according to the study of customer needs and improving all gaps of the existing models. Dual sensor startup and light sensors to alert water tray full / brush motors finishing / EPA E11 filter change need. All these features allowing easy monitoring of the life cycle of the product and minimize the need for technical assistance, in particular all urgencies due to a lack of maintenance - monitoring by the final customer.

**Integrated care:** antibacterial protection and environmental protection, guaranteed by the EPA E11 filter against 99.997 % of bacteria present in the air and by the collection of residual water in the tank, no longer draining to the ground.

**Designing the future:** contemporary design & completely Made in Italy.

 **Facilité et ergonomie:** l'insertion des mains à l'horizontale combine l'ergonomie et l'accessibilité pour tous les groupes d'utilisateurs.

**Moins de consommation... super- vitesse et économies d'énergie extrêmes:** optimisation des flux d'air à travers le système à 4 lames d'aire circulaire: vitesse 425 km / h et séchage en 10-12 secondes.

**Puissance totale:** seulement 1100 W, **absence de résistance**, une économie de plus de 95 % par rapport à d'autres systèmes de séchage.

**Conception orientée vers le client:** conçu et développé selon l'étude des besoins des clients et par rapport au "talon d'Achille" des modèles existants. Deux capteurs pour le démarrage et avis de lumière pour alerte: bac colissage d'eau plein / brosses de moteur a changer / nettoyage du filtre EPA E11. Donc cela facilite le contrôle du cycle de vie du produit et minimise le besoin d'assistance technique, en particulier aux urgences en raison d'un manque d'entretien suivi par le client final.

**Les soins intégrés:** protection antibactérienne et de l'environnement d'utilisation, garanti par le filtre EPA E11 contre 97,66% des bactéries présentes dans l'air, et par la récupération de l'eau résiduelle dans le réservoir, sans l'écoulement sur le sol.

**Concevoir le futur:** conception, design contemporaine, manufacturé entièrement en Italie.



Il filtro EPA E11 garantisce protezione contro il 97,66% dei batteri\* presenti nell'aria che viene utilizzata durante l'asciugatura

*EPA E11 filter allows protection against 97,66% of bacterials\*, spreading clean air on hands*

Le filtre EPA E11 assure une protection de 97,66% contre les bactéries\* contenues dans l'air au cours du séchage

\*Certificato da ALTIFILTER - Certificate from ALTIFILTER - Certification ALTIFILTER





 Inserimento orizzontale delle mani

 Hands through drying style

 La conception ergonomique permet l'insertion des mains d'une manière naturelle.

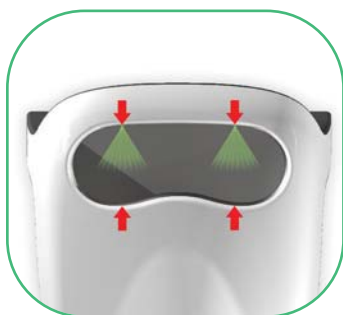

Doppio sensore di avvio\*

Double sensor operating\*

Double capteur électronique\*

\* PRO setting (pag. 16)





Asciugatura superveloce con 4 lame d'aria circolari

4 air nozzles for fastest hand drying

Les 4 prises d'air permettent au flux d'air de sécher avec une efficacité maximale grâce à un petit massage



 Design ergonomico & innovativo, con versioni in ABS colore bianco (BF) & grigio satinato (SF)

 Attractive design, white ABS (BF) and satin-grey (SF)

 Design ergonomique, ABS blanc (BF) et ABS satin gris (SF)



L'acqua viene canalizzata nella vaschetta di raccolta alla base dell'apparecchio, evitando il gocciolamento a terra e consentendo il massimo dell'igiene e della sicurezza

The water tank avoids dripping on floors, pollution and bad smells. Ready and fast to empty and clean, it is warranty of maximum hygiene

L'eau est canalisée dans le bac de collecte à la base de l'appareil, en évitant les gouttes sur le sol, donnant une meilleure hygiène et une sécurité maximale



**LED per monitoraggio del ciclo di asciugatura:** stand-by; in funzione; fine ciclo. 

**Sensori luminosi per una veloce diagnosi dello stato di funzionamento:**

1) sensore per pulizia filtro EPA E11; 2) sensore per avviso di svuotamento vaschetta; 3) sensore per check motore (consumo spazzole)\*

**Luminous LED for a quick check of the drying cycle:** stand-by; operating; cycle end. 

**Luminous frontal LED for a quick diagnosis of the hand dryer status:**

1) EPA E11 filter check sensor; 2) full water tank sensor; 3) motor brushes check sensor\*

**Lumineux à LED pour un contrôle rapide du cycle de séchage:** stand-by; exploitation; fin de cycle. 

**LED frontales lumineux pour une rapide diagnostic de l'état de sèche-mains:**

1) Avis nettoyage filtre EPA E11; 2) Avis réservoir d'eau plein; 3) Avis change balais de moteur\*

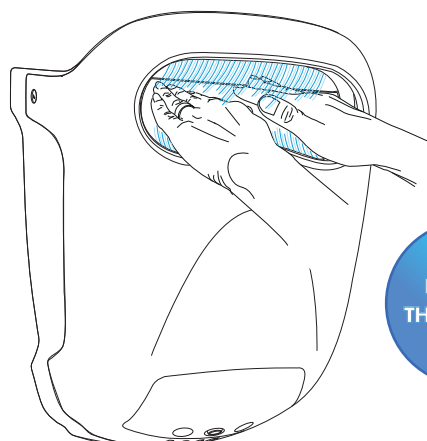

\* PRO setting (pag. 16)



HANDS THROUGH





-  **ARTICOLI & CODICI PRODOTTO**
-  **MODEL REFERENCE CHART**
-  **TABLEAU DES MODÈLE DE RÉFÉRENCE**



Cod.		Setting	Cod.		Setting
VISION AIR BF EASY	ABS Bianco / White / Blanc	EASY	VISION AIR SF EASY	ABS grigio / grey / gris	EASY
VISION AIR BF PRO	ABS Bianco / White / Blanc	PRO	VISION AIR SF PRO	ABS grigio / grey / gris	PRO





















Il filtro EPA E11 (opzione) garantisce protezione contro il 97,66% dei batteri\* presenti nell'aria che viene utilizzata durante l'asciugatura

*EPA E11 filter (option) allows protection against 97,66% of bacteria\*, spreading clean air on hands*

Le filtre EPA E11 en option) assure une protection de 97,66% contre les bactéries\* contenues dans l'air au cours du séchage

\*Certificato da ALTI FILTER - Certificate from ALTI FILTER - Certification ALTI FILTER



	EASY SETTING	PRO SETTING
 Sensore di avvio con autospegnimento di sicurezza	✓	✓
 Sensor operating, with safety auto turn-off	✓	✓
 Capteur électronique avec arrêt automatique de sécurité	✓	✓
 Vaschetta di raccolta d'acqua	✓	✓
 Water tank	✓	✓
 Bac de collecte d'eau	✓	✓
 Filtro EPA E11	✗	✓
 EPA E11 filter	Opzione - Option - En option	
 Filtre EPA E11	✗	✓
 Doppio sensore di avvio	✗	✓
 Double sensor operating	✗	✓
 Double capteur électronique	✗	✓
 LED per monitoraggio del ciclo di asciugatura	✗	✓
 Luminous led for a quick check of the drying cycle	✗	✓
 Lumineux à LED pour un contrôle rapide du cycle de séchage	✗	✓
 Sensori luminosi: check filtro EPA E11, avviso vaschetta piena, check motore (consumo spazzole)	✗	✓
 Luminous leds: EPA E11 filter check sensor, full water tank sensor, motor brushes check sensor	✗	✓
 Leds lumineux: check filtre EPA E11, avis réservoir d'eau plein, check balais de moteur	✗	✓

### ASCIUGAMANI - HAND DRYERS - SÈCHE-MAINS

- CONFRONTO COSTI DI ASCIUGATURA ANNUALI
- ANNUAL SAVINGS CALCULATION
- CALCULEZ VOS COÛTS/ECONOMIES ANNUELLES

N° UTILIZZI GIORNALIERI DAILY USE UTILISATION PAR JOUR		COTONE COTTON COTON	CARTA PAPER PAPIER	ASCIUGAMANI TRADIZIONALI 2400 W TRADITIONAL HAND DRYERS 2400 W SÈCHE-MAINS STANDARD 2400 W
100	€ 22,05 / anno	€ 949,00	€ 730,00	€ 104,04
200	€ 44,10 / anno	€ 1.898,00	€ 1.460,00	€ 205,91
400	€ 88,19 / anno	€ 3.504,00	€ 2.920,00	€ 409,65



Calcoli basati su 100 / 200 / 400 utilizzi al giorno nonché sull'utilizzo di 1 unità. Costo dell'energia di € 0,1655/kWh; costo di € 0,01 per salvietta di carta, con una media di 2 salviette per asciugatura. I costi effettivi possono variare.



Based on 100 / 200 / 400 uses per day.  
Energy cost € 0,1655/kWh; paper cost € 0,01 per sheet, with use of two sheets at once.



Calculs basés sur 100 / 200 / 400 utilisations par jour et l'utilisation de 1 unité. Coût en énergie de € 0,1655/kWh; coût de € 0,01 pour les serviettes en papier, avec une moyenne de 2 serviettes de toilette pour le séchage. Coûts réels peuvent varier.

#### CARATTERISTICHE TECNICHE / TECHNICAL FEATURES / CARACTÉRISTIQUES TECHNIQUES

Funzionamento	Doppio sensore di rilevam. elettronico a raggi infrarossi
Functioning	Sensor operating
Activation	Capteur électronique
Giri al minuto	
Tr min	32000 rpm
Révolutions par minute	
Grado di protezione elettrica	
Electrical Protection Level	IP44 - CLASS II
Isolation électrique	
Tensione	
Supply Voltage	220 V-240 V
Tension d'alimentation	
Volume aria	
Air Flow	187 m <sup>3</sup> /h - 52 l/s
Débit d'air	
Potenza totale	
Total power	1100 W
Puissance totale	
Potenza resistenza	Nessuna resistenza
Absorption Heating Element	No heating element
Puissance chauffage	Pas de chauffage
Potenza motore	
Absorption Motor	1100 W
Puissance moteur	
Dimensioni A x L x P	
Dimensions H x W x D	442 x 350 x 233 (mm)
Dimensions H x L x P	
Frequenza	
Frequency	50-60 Hz
Fréquence	

Velocità aria	
Air Speed	425 km/h
Vitesse d'air	
Peso	
Weight	4,5 Kg
Poids net	
Materiale	
Materials	ABS
Matériel	
Marchi di qualità	
Quality marks - certifications	CE RoHS WEEE GOST
Certification	
Rumorosità (2 mt)	
Noise Level (2 mt)	75 dB
Niveau sonore (2 mt)	
Garanzia	3 anni *
Warranty	3 years *
Garantie	3 ans *

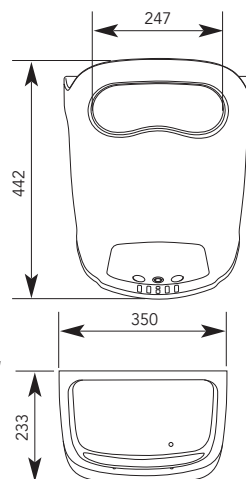

ALTEZZA DI INSTALLAZIONE DA TERRA  
PUNTO DI INSERIMENTO DELLE MANI  
INSTALLATION HEIGHT FROM FLOOR  
POINT OF ENTRY OF HANDS  
HAUTEUR D'INSTALLATION DE PLANCHER  
POINT D'ENTRÉE DES MAINS



\* Per le limitazioni di garanzia si vedano le condizioni generali di servizio

\* Limited warranty. Please have a look to the General Warranty Conditions for details and consumables

\* Limitations de garantie: revoir Conditions de Garantie Generale



# ARIEL



**VELOCITÀ ASCIUGATURA**  
*DRYING TIME / TEMPS DE SÉCHAGE*



**RISPARMIO ENERGETICO**  
*ENERGY SAVING / ÉPARGNE ENERGETIQUE*



**SILENZIOSITÀ**  
*NOISELESS / SILENCIEUX*



**DESIGN**





**ANTIVANDALISMO**  
*ANTIVANDALISM / ANTIVANDALISME*





- 

Asciugamani antivandalo, potenza 2400 W o nella versione a risparmio energetico 1700 W, con scocca in acciaio e bocchettone girevole a 360°, funzionamento a pulsante o sensore di rilevamento elettronico a raggi infrarossi. Temporizzazione regolabile da 25" a 180". Doppio termostato per la massima sicurezza, sia sulla resistenza che sul motore. Disponibile in acciaio INOX AISI 304 lucido, satinato e nella versione a smalto colore bianco. Personalizzazioni con altri colori a richiesta.
- 

Antivandal hand dryer, power 2400 W or economy version 1700 W, steel cover, 360° revolving nozzle, push button or infrared sensor operating. Adjustable timer between 25" and 180". Double thermostat, on both engine and heating element. Available in white porcelainized, bright or satin INOX AISI 304 steel. Other colors available on request.
- 

Sèche-mains antivandalisme en acier, puissance 2400 W ou 1700 W d'économie, le bouton poussoir ou capteur automatique, avec tuyère orientable 360 degrés. Double thermostat de sécurité, minuterie réglable entre 25" et 180". Disponible en blanc, acier INOX AISI 304 brillant, INOX AISI 304 satin. Autres couleurs disponibles.

### GARANZIA 3 ANNI • WARRANTY 3 YEARS • GARANTIE 3 ANS



ARIEL è disponibile anche nella versione a incasso, con box in acciaio INOX AISI 304 satinato e sistema di chiusura antivandalo. Funzionamento automatico con sistema di autospegnimento antivandalico dopo 60 secondi.

*ARIEL is also available in recessed version, with satin AISI 304 stainless steel case, vandal-proof lock screws and key wrench. Automatic operation hand dryer with power cut off in case of irregular use over 60 seconds.*

Ariel est également disponible en version encastrée murale, avec une structure en acier inox AISI 304 satiné anti-vandalisme. Système capteur avec l'auto-désactivation anti vandalisme après 60 secondes.

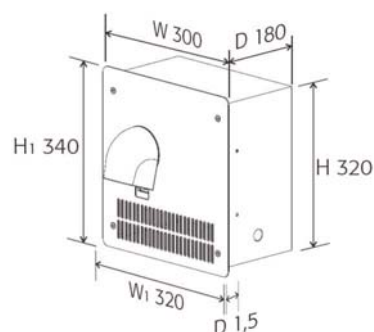

### ASCIUGAMANI- HAND DRYERS - SÈCHE-MAINS



**ARIEL /BP**  
Acciaio porcellanato bianco,  
funzionante a pulsante.  
*White steel porcelained, push  
button operating.*  
Acier blanc, bouton poussoir.



**ARIEL /SP**  
Acciaio inox AISI 304 satinato,  
funzionante a pulsante.  
*Satin AISI 304 stainless steel,  
push button operating.*  
Acier inox AISI 304 satin,  
bouton poussoir.



**ARIEL /LP**  
Acciaio inox AISI 304 lucido,  
funzionamento a pulsante.  
*Bright AISI 304 stainless steel,  
push button operating.*  
Acier inox AISI 304 brillant,  
bouton poussoir.



**ARIEL /BF**  
Acciaio porcellanato bianco,  
funzionamento automatico.  
*White steel porcelained,  
infrared sensor operating.*  
Acier blanc, capteur  
electronique.



**ARIEL /SF**  
Acciaio inox AISI 304 satinato,  
funzionamento automatico.  
*Satin AISI 304 stainless steel,  
infrared sensor operating.*  
Acier inox AISI 304 satin,  
capteur electronique.



**ARIEL /LF**  
Acciaio inox AISI 304 lucido,  
funzionamento automatico.  
*Bright AISI 304 stainless steel,  
infrared sensor operating.*  
Acier inox AISI 304 brillant,  
capteur electronique.

#### CARATTERISTICHE TECNICHE / TECHNICAL FEATURES / CARACTÉRISTIQUES TECHNIQUES

Funzionamento	Pulsante o Automatico a sensore	Volume aria	
Functioning	Push button or sensor operating	Air Flow	330 m <sup>3</sup> /h - 91 l/s
Activation	Poussoir ou capteur electronique	Débit d'air	
Giri al minuto		Peso	
Tr min	5500 rpm	Weight	4,8 Kg - 9,6 Kg ARIEL SCL
Révolutions par minute		Poids net	
Grado di protezione elettrica		Materiale	Acciaio
Electrical Protection Level	IPX1 - CLASS I	Materials	Steel
Isolation électrique		Matériel	Acier
Tensione		Marchi di qualità	
Supply Voltage	220 V-240 V	Quality marks - certifications	CE
Tension d'alimentation		Certification	
Potenza totale		Rumorosità (2 mt)	
Total power	2400 W - 1700 W (energy saving)	Noise Level (2 mt)	70 dB
Puissance totale		Niveau sonore (2 mt)	
Potenza resistenza		Garanzia	3 anni *
Absorption Heating Element	2200W or 1500 W	Warranty	3 years *
Puissance chauffage		Garantie	3 ans *
Potenza motore			
Absorption Motor	200W		
Puissance moteur			
Dimensioni A x L x P			
Dimensions H x W x D	243 x 278 x 213 (mm)		
Dimensions H x L x P			
Frequenza			
Frequency	50-60 Hz		
Fréquence			
Velocità aria			
Air Speed	101 Km/h		
Vitesse d'air			

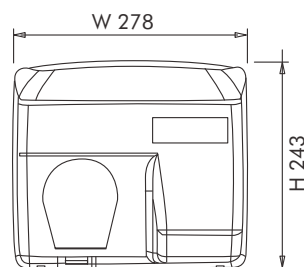
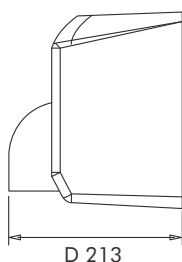

🇮🇹 \* Per le limitazioni di garanzia si vedano le condizioni generali di servizio

🇬🇧 \* Limited warranty. Please have a look to the General Warranty Conditions for details and consumables

🇫🇷 \* Limitations de garantie: revoir Conditions de Garantie Generale





# U-nik®



**VELOCITÀ ASCIUGATURA**  
*DRYING TIME / TEMPS DE SÉCHAGE*



**RISPARMIO ENERGETICO**  
*ENERGY SAVING / ÉPARGNE ENERGETIQUE*



**SILENZIOSITÀ**  
*NOISELESS / SILENCIEUX*



**DESIGN**



**ANTIVANDALISMO**  
*ANTIVANDALISM / ANTIVANDALISME*



# U-nik®



**L'ASCIUGAMANI SILENZIOSO, AFFIDABILE,  
CON OTTIMO RAPPORTO QUALITÀ-PREZZO: UNIK®**

- Ideale per aree a traffico medio / ridotto
- Ottimo rapporto tra performance / consumi / budget di spesa
- Massima silenziosità: inferiore a 60 db
- Nessuna manutenzione, motore a induzione
- Timer regolabile tra 30 sec. - 3 min.
- Design contemporaneo e grande varietà di gamma (disponibile in colore bianco, grigio-satinato e cromato-lucido)

**THE NOISELESS, RELIABLE, CHEAPEST HAND DRYER: UNIK®**

- The best for medium-low transit area
- The best balance between performance / electricity consumption / budget
- Noiseless: less than 60 db
- No need of maintenance, brushless motors
- Adjustable timer (30 sec. - 3 min.)
- Contemporary design and wide range (white, satin-grey, bright)

**LE SÈCHE-MAINS SILENCIEUX, FIABLE, AVEC UN RAPPORT EXCELLENT QUALITÉ/PRIS: UNIK UNIK®**

- Idéal pour les zones de trafic (moyen / faible)
- Bonne relation entre performance / consommation / budget des dépenses
- Niveau de bruit maximum: moins de 60 db
- Pas d'entretien, moteur à induction
- Timer réglable de 30 sec. - 3 min.
- Design contemporain et variété de gamme (disponible en blanc, gris et chromé)

**GARANZIA 3 ANNI • WARRANTY 3 YEARS • GARANTIE 3 ANS**



WEEE





### ASCIUGAMANI - HAND DRYERS - SÈCHE-MAINS



#### UNIK /BP

ABS bianco a pulsante

*ABS white push button*

ABS blanc, bouton poussoir



#### UNIK /BF

ABS bianco, funzionamento automatico

*ABS white sensor operating*

ABS blanc, capteur électronique



#### UNIK /LF

ABS cromato lucido, funzionamento automatico

*ABS bright chrome cover, sensor operating*

ABS chromé brillant, capteur électronique



#### UNIK /SF

ABS grigio satinato, funzionamento automatico

*ABS satin gray cover, sensor operating*

ABS gris satiné, capteur électronique

### CARATTERISTICHE TECNICHE / TECHNICAL FEATURES / CARACTÉRISTIQUES TECHNIQUES

Funzionamento	Pulsante o Automatico a sensore
Functioning	Push button or sensor operating
Activation	Poussoir ou capteur électronique
Giri al minuto	
T <sub>r</sub> min	2800 rpm
Révolutions par minute	
Grado di protezione elettrica	
Electrical Protection Level	IPX2 - CLASS II
Isolation électrique	
Tensione	
Supply Voltage	220 V-240 V
Tension d'alimentation	
Potenza totale	
Total power	1850 W
Puissance totale	
Potenza resistenza	
Absorption Heating Element	1785 W
Puissance chauffage	
Potenza motore	
Absorption Motor	65 W
Puissance moteur	
Dimensioni A x L x P	
Dimensions H x W x D	305 x 262 x 165 (mm)
Dimensions H x L x P	
Frequenza	
Frequency	50-60 Hz
Fréquence	
Velocità aria	
Air Speed	80 Km/h
Vitesse d'air	

Volume aria	
Air Flow	160 m <sup>3</sup> /h - 45 l/s
Débit d'air	
Peso	
Weight	3 kg
Poids net	
Materiale	
Materials	ABS
Matériel	
Marchi di qualità	
Quality marks - certifications	CE
Certification	
Rumorosità (2 mt)	
Noise Level (2 mt)	60 db
Niveau sonore (2 mt)	
Garanzia	3 anni
Warranty	3 years
Garantie	3 ans

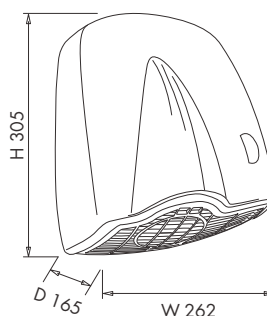

# AEA - TURBOTIME - TURBOTRONIC

ASCIUGAMANI - HAND DRYERS - SÈCHE-MAINS

ASCIUGAMANI IN ABS - ABS HAND DRYERS - SÈCHE-MAINS EN ABS



## **GLI ASCIUGAMANI DI ALTA QUALITA' IN ABS DELLA TRADIZIONE VAMA**

- Ideale per aree a traffico medio / ridotto
- Ottimo rapporto tra performance / consumi / budget di spesa
- Massima silenziosità: inferiore a 60 db
- Nessuna manutenzione, motore a induzione
- Elegante e pratico specchio in acciaio inox nelle versioni AEA

## **THE HIGH QUALITY ABS HAND DRYER: 100 % VAMA TRADITION**

- The best for medium-low transit area
- The best balance between performance / electricity consumption / budget
- Noiseless: less than 60 db
- No need of maintenance, brushless motors
- Elegant and useful mirror (AEA models)

## **LES SÈCHE-MAINS DE HAUTE QUALITÉ TRADITIONNELS VAMA**

- Idéal pour les zones de trafic (moyen / faible)
- Bonne relation entre performance / consommation / budget des dépenses
- Niveau de bruit maximum: moins de 60 db
- Pas d'entretien, moteur à induction
- Élégant et pratique miroir en acier inoxydable dans les versions AEA

**GARANZIA 2 ANNI • WARRANTY 2 YEARS • GARANTIE 2 ANS**



WEEE

# AEA - TURBOTIME - TURBOTRONIC

ASCIUGAMANI - HAND DRYERS - SÈCHE-MAINS

ASCIUGAMANI IN ABS - ABS HAND DRYERS - SÈCHE-MAINS EN ABS



## AEA/87

1600 W, funzionante a pulsante  
1600 W, push-button  
1600 W, bouton poussoir



## AEA/SUPER/87

2000 W, funzionante a pulsante  
2000 W, push-button  
2000 W, bouton poussoir



## AEA/E/87

1600 W, funzionamento automatico  
1600 W, sensor operating  
1600 W, capteur



## AEA/E/SUPER/87

2000 W, funzionamento automatico  
2000 W, sensor operating  
2000 W, capteur



## TURBOTIME /98

1800 W, funzionante a pulsante  
1800 W, push-button  
1800 W, bouton poussoir



## TURBOTRONIC/98

1800 W, funzionamento automatico  
1800 W, sensor operating  
1800 W, capteur

### CARATTERISTICHE TECNICHE COMUNI COMMON TECHNICAL FEATURES CARACTÉRISTIQUES TECHNIQUES COMMUNES

Giri al minuto	
Tr min	2800 rpm
Révolutions par minute	
Grado di protezione elettrica	
Electrical Protection Level	IPX2 - CLASS II
Isolation électrique	
Tensione	
Supply Voltage	220 V-240 V
Tension d'alimentation	
Frequenza	
Frequency	50-60 Hz
Fréquence	
Velocità aria	
Air Speed	80 Km/h
Vitesse d'air	
Volume aria	
Air Flow	160 m <sup>3</sup> /h - 45 l/s
Débit d'air	
Materiale	
Materials	ABS
Matériel	
Marchi di qualità	
Quality marks - certifications	CE
Certification	
Rumorosità (2 mt)	
Noise Level (2 mt)	60 db
Niveau sonore (2 mt)	
Garanzia	2 anni
Warranty	2 years
Garantie	2 ans

### AEA - AEA/E

Caratteristiche specifiche / Specific features / Caractéristiques spécifiques

Dimensioni A x L x P	
Dimensions H x W x D	275 x 210 x 205 (mm)
Dimensions H x L x P	
Peso	
Weight	2,6 kg
Poids net	
Potenza totale	
Total power	1600 W - 2000 W (super)
Puissance totale	

### TURBOTIME - TURBOTRONIC

Caratteristiche specifiche / Specific features / Caractéristiques spécifiques

Dimensioni A x L x P	
Dimensions H x W x D	320 x 215 x 155 (mm)
Dimensions H x L x P	
Peso	
Weight	3 kg
Poids net	
Potenza totale	
Total power	1800 W
Puissance totale	

### AEA - AEA/E

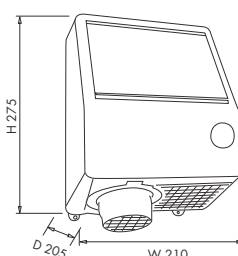

### TURBOTIME TURBOTRONIC

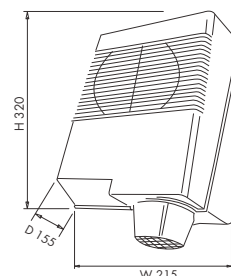











***ASCIUGACAPELLI LINEA HOTEL***

*Hair dryers Hotel line - Sèche-cheveux Ligne hotel*

-  - Asciugacapelli per hotel di fascia premium.
  - Corpo in ABS con eleganti finiture cromate.
  - 3 regolazioni di velocità aria / temperatura.
  - Pulsante a rilascio di sicurezza.
  - Termostato di sicurezza sulla resistenza.
  - Cavo spiralato flessibile di alimentazione, lunghezza 60/120 cm.
-  - Premium hotel hair dryer.
  - White ABS & elegant chrome finish.
  - 3 heat / speed settings.
  - Push-release button.
  - Overheating protection.
  - Flexible cable length 60/120 cm, with plug.
-  - Sèche-cheveux pour les équipements supérieurs de l'hotel.
  - Corps en ABS avec élégante finition chrome.
  - 3 réglages thermique / vitesse.
  - Bouton d'activation de sécurité a pression.
  - Thermostat de sécurité.
  - Cablage en spirale flexible 60/120 cm, avec prise bipolaire.



**GARANZIA 2 ANNI • WARRANTY 2 YEARS • GARANTIE 2 ANS**

**CARATTERISTICHE TECNICHE / TECHNICAL FEATURES / CARACTÉRISTIQUES TECHNIQUES**

Funzionamento	Pulsante a rilascio di sicurezza
Functioning	Push / release button
Activation	Bouton-poussoir de sécurité
Grado di protezione elettrica	
Electrical Protection Level	CLASS II
Isolation électrique	
Tensione	
Supply Voltage	220 V - 240 V
Tension d'alimentation	
Potenza complessiva	3 regolazioni max. 1800 W
Power	3 settings max. 1800 W
Puissance	3 réglages max. 1800 W
Dimensioni A x L x P	
Dimensions H x W x D	220 x 205 x 81 (mm)
Dimensions H x L x P	
Frequenza	
Frequency	50-60 Hz
Fréquence	
Volume aria	
Air Flow	max. 26 l/s
Débit d'air	
Peso	
Weight	0,580 Kg
Poids net	

Materiale	
Materials	ABS
Matériel	
Marchi di qualità	
Quality marks - certifications	CE RoHs
Certification	
Garanzia	2 anni
Warranty	2 years
Garantie	2 ans

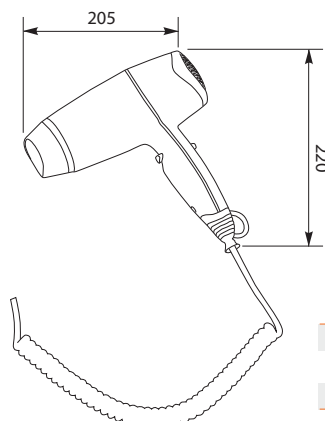



## COMFORT PRO

-  - Base a muro in ABS con elegante finitura cromata.
- Cavo spiralato flessibile tra l'asciugacapelli e la base a muro, lunghezza 60/120 cm.
- Cavo lineare di alimentazione con spina bipolare dalla base a muro, lunghezza 90 cm.
- Interruttore ON - OFF sulla base a muro.

-  - ABS wall base with elegant chrome finish.
- Flexible cable between hair dryer/wall base, length 60/120 cm.
- Linear supply cable with plug from wall base, length 90 cm.
- ON - OFF safety switch button on wall-base.

-  - Support mural en ABS avec élégante finition chrome.
- Cablage en spirale flexible entre sèche-cheveux et la base murale, longueur 60/120 cm.
- Cable linéaire d'alimentation avec prise bipolaire, longueur 90 cm.
- Interrupteur ON - OFF de sécurité sur la base murale.





**GARANZIA 2 ANNI • WARRANTY 2 YEARS • GARANTIE 2 ANS**

### CARATTERISTICHE TECNICHE / TECHNICAL FEATURES / CARACTÉRISTIQUES TECHNIQUES

Funzionamento	Pulsante a rilascio di sicurezza
Functioning	Push / release button
Activation	Bouton-poussoir de sécurité
Grado di protezione elettrica	
Electrical Protection Level	CLASS II
Isolation électrique	
Tensione	
Supply Voltage	220 V - 240 V
Tension d'alimentation	
Potenza complessiva	3 velocità max. 1800 W
Power	3 speeds max. 1800 W
Puissance	3 vitesses max. 1800 W
Dimensioni A x L x P	
Dimensions H x W x D	220 x 250 x 140 (mm)
Dimensions H x L x P	
Frequenza	
Frequency	50-60 Hz
Fréquence	
Volume aria	
Air Flow	max. 26 L/s
Débit d'air	
Peso	
Weight	0,820 Kg
Poids net	

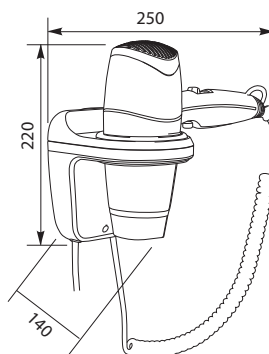
Materiale	
Materials	ABS
Matériel	
Marchi di qualità	
Quality marks - certifications	CE RoHs
Certification	
Garanzia	2 anni
Warranty	2 years
Garantie	2 ans





-  - Asciugacapelli per hotel di fascia premium.
- Corpo in ABS con eleganti finiture cromate.
- **Manico pieghevole per il minimo ingombro in larghezza.**
- 3 regolazioni di velocità aria / temperatura.
- Pulsante a rilascio di sicurezza.
- Termostato di sicurezza sulla resistenza.
- Cavo spiralato flessibile di alimentazione, lunghezza 60/120 cm.

-  - **Premium hotel hair dryer.**
- White ABS & elegant chrome finish.
- **Foldable handle.**
- 3 heat / speed settings.
- Push-release button.
- Overheating protection.
- Flexible cable length 60/120 cm, with plug.

-  - **Sèche-cheveux pour les équipements supérieurs de l'hôtel.**
- Corps en ABS avec élégante finition chrome.
- **Poignée pliable pour largeur minimale.**
- 3 réglages thermique / vitesse.
- Bouton d'activation de sécurité à pression.
- Thermostat de sécurité.
- Cable a spirale 60/120 cm, avec prise bipolaire.



-  **Sacchetto porta phon (opzionale)**
-  **Hair dryer bag (option)**
-  **Sac porte sèche cheveux (optionnel)**



VIENTO SPACE  
PLUG

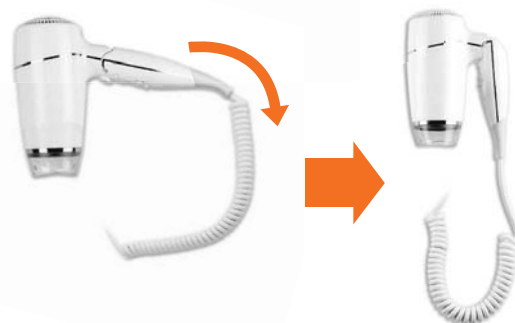

**GARANZIA 2 ANNI • WARRANTY 2 YEARS • GARANTIE 2 ANS**

### CARATTERISTICHE TECNICHE / TECHNICAL FEATURES / CARACTÉRISTIQUES TECHNIQUES

Funzionamento	Pulsante a rilascio di sicurezza
Functioning	Push / release button
Activation	Bouton-poussoir de sécurité
Grado di protezione elettrica	
Electrical Protection Level	CLASS II
Isolation électrique	
Tensione	
Supply Voltage	220 V - 240 V
Tension d'alimentation	
Potenza complessiva	3 velocità max. 1650 W
Power	3 speeds max. 1650 W
Puissance	3 vitesses max. 1650 W
Dimensioni A x L x P	
Dimensions H x W x D	190 x 270 (130) x 77 (mm)
Dimensions H x L x P	
Frequenza	
Frequency	50-60 Hz
Fréquence	
Volume aria	
Air Flow	max. 26 L/s
Débit d'air	
Peso	
Weight	0,500 Kg
Poids net	

Materiale	
Materials	ABS
Matériel	
Marchi di qualità	
Quality marks - certifications	CE RoHs
Certification	
Garanzia	2 anni
Warranty	2 years
Garantie	2 ans

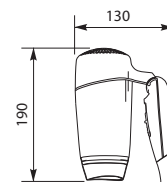
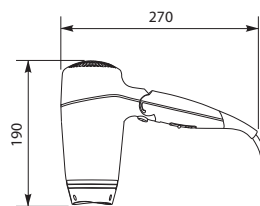

Profondità	
Depth	77 mm
Profondeur	

## VIENTO SPACE

- Base a muro in ABS.
- **Manico pieghevole per il minimo ingombro in larghezza.**
- Interruttore on-off sulla base a muro.
- Cavo spiralato flessibile tra l'asciugacapelli e la base a muro, lunghezza 60/120 cm.
- Cavo lineare di alimentazione con spina bipolare dalla base a muro, lunghezza 90 cm.

- ABS wall base.
- **Foldable handle.**
- ON - OFF safety switch button on wall-base.
- Flexible cable between hair dryer/wall base, length 60/120 cm.
- Linear supply cable with plug from wall base, length 90 cm.

- Support mural en ABS.
- **Poignée pliable pour largeur minimale.**
- Interrupteur ON - OFF de sécurité sur la base murale.
- Cablage en spirale flexible entre sèche-cheveux et la base murale, longueur 60/120 cm.
- Cable linéaire d'alimentation avec prise bipolaire, longueur 90 cm.

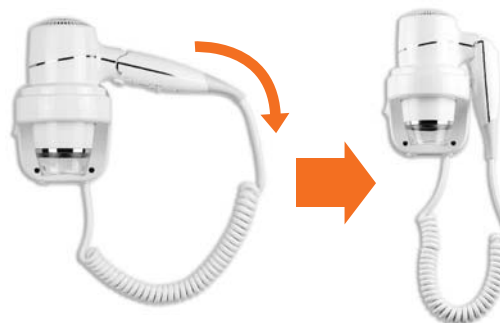

**GARANZIA 2 ANNI • WARRANTY 2 YEARS • GARANTIE 2 ANS**

### CARATTERISTICHE TECNICHE / TECHNICAL FEATURES / CARACTÉRISTIQUES TECHNIQUES

Funzionamento	Pulsante a rilascio di sicurezza
Functioning	Push / release button
Activation	Bouton-poussoir de sécurité
Grado di protezione elettrica	
Electrical Protection Level	CLASS II
Isolation électrique	
Tensione	
Supply Voltage	220 V - 240 V
Tension d'alimentation	
Potenza complessiva	3 velocità max. 1650 W
Power	3 speeds max. 1650 W
Puissance	3 vitesses max. 1650 W
Dimensioni A x L x P	
Dimensions H x W x D	190 x 270 (145) x 140 (mm)
Dimensions H x L x P	
Frequenza	
Frequency	50-60 Hz
Fréquence	
Volume aria	
Air Flow	max. 26 L/s
Débit d'air	
Peso	
Weight	0,760 Kg
Poids net	

Materiale	
Materials	ABS
Matériel	
Marchi di qualità	
Quality marks - certifications	CE RoHs
Certification	
Garanzia	2 anni
Warranty	2 years
Garantie	2 ans

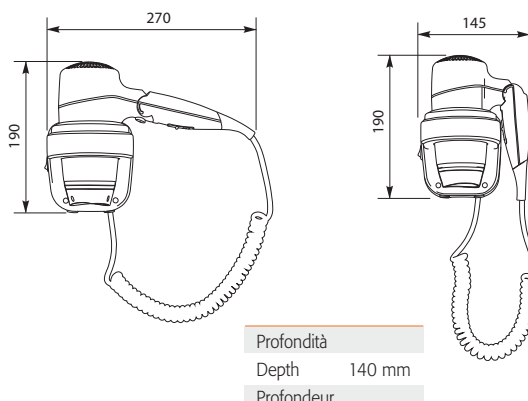

Profondità	
Depth	140 mm
Profondeur	





-  - Asciugacapelli per hotel di fascia premium.
  - Corpo in ABS con eleganti finiture cromate.
  - 3 regolazioni di velocità aria / temperatura.
  - Pulsante a rilascio di sicurezza.
  - Termostato di sicurezza sulla resistenza.
  - Cavo spiralato flessibile di alimentazione con spina bipolare lunghezza 60/120 cm.

-  - Premium hotel hair dryer.
  - White ABS & elegant chrome finish.
  - 3 heat / speed settings.
  - Push-release button.
  - Overheating protection.
  - Flexible cable with plug, length 60/120 cm.

-  - Sèche-cheveux pour les équipements supérieurs de l'hotel.
  - Corps en ABS avec élégante finition chrome.
  - 3 réglage de la vitesse de l'air / température.
  - Bouton d'activation de sécurité a pression.
  - Thermostat de sécurité.
  - Cablage en spirale flexible avec prise bipolaire, longueur 60/120 cm.



-  Sacchetto porta phon (opzionale)
-  Hair dryer bag (option)
-  Sac porte sèche cheveux (optionnel)



**GARANZIA 2 ANNI • WARRANTY 2 YEARS • GARANTIE 2 ANS**

### CARATTERISTICHE TECNICHE / TECHNICAL FEATURES / CARACTÉRISTIQUES TECHNIQUES

Funzionamento	Pulsante a rilascio di sicurezza
Functioning	Push / release button
Activation	Bouton-poussoir de sécurité
Grado di protezione elettrica	
Electrical Protection Level	CLASS II - IP 21
Isolation électrique	
Tensione	
Supply Voltage	220 V - 240 V
Tension d'alimentation	
Potenza complessiva	3 regolazioni max. 1200 W
Power	3 settings max. 1200 W
Puissance	3 réglages max. 1200 W
Dimensioni A x L x P	
Dimensions H x W x D	215 x 160 x 75 (mm)
Dimensions H x L x P	
Frequenza	
Frequency	50-60 Hz
Fréquence	
Volume aria	
Air Flow	16,66 - 26,38 l/s (60 - 95 cbm/h)
Débit d'air	
Peso	
Weight	0,460 Kg
Poids net	

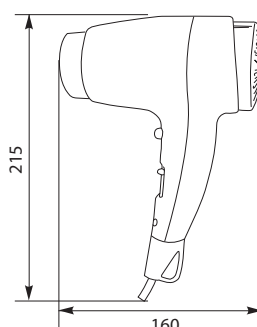

Materiale	
Materials	ABS
Matériel	
Marchi di qualità	
Quality marks - certifications	CE RoHS
Certification	
Garanzia	2 anni
Warranty	2 years
Garantie	2 ans
Termostato di sicurezza	
Safety Thermostat	
Thermostat de sécurité	



Profondità	
Depth	75 mm
Profondeur	

## ELEGANT PRO BASIC



-  Base murale **Standard** in ABS bianco.
-  White ABS **Standard** wall-base.
-  Support mural **Standard** en ABS blanc.

Potenza complessiva	3 regolazioni max. 1500 W	
Power	3 settings max. 1500 W	
Puissance	3 réglages max. 1500 W	
Profondità	Peso	
Depth 140 mm	Weight	0,700 Kg
Profondeur	Poids net	

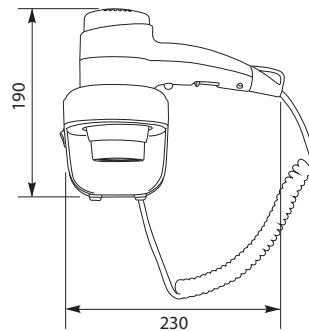



- Interruttore di sicurezza ON / OFF sulla base a muro
- ON - OFF safety switch button on wall-base
- ON - OFF Interrupteur de sécurité sur la base mural
- Cavo spiralato flessibile tra asciugacapelli / base a muro, lunghezza 60/120 cm
- Flexible cable between hair dryer / wall base, length 60/120 cm
- Cable a spirale entre support mural / sèche-cheveux, longueur 60/120 cm
- Cavo lineare di alimentazione con spina bipolare, lunghezza 90 cm
- Linear supply cable with plug, length 90 cm
- Cable linéaire d'alimentation avec prise bipolaire, longueur 90 cm

## ELEGANT PRO SHAVER



IP 21

-  Base murale in ABS bianco, con presa rasoio 220/110 V. Livello di protezione **IP21**. Potenza max. **1200 W**.
-  White ABS wall-base, with 220/110 V shaver socket. **IP21** ingress protection level. Power max. **1200 W**.
-  Support mural en ABS blanc, avec prise rasoir bipolaire 220/110 V. Niveau de protection **IP21**. **Installation volume 3**. Isolation électrique Class II. Puissance **1200 W**.

Profondità	Peso	
Depth 105 mm	Weight	0,850 Kg
Profondeur	Poids net	

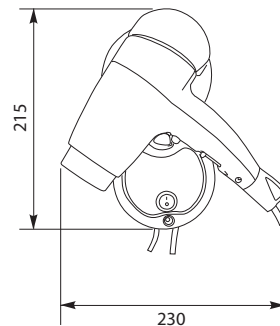

- Interruttore di sicurezza ON / OFF sulla base a muro
- ON - OFF safety switch button on wall-base
- ON - OFF Interrupteur de sécurité sur la base mural
- Presa rasoio
- Shaver socket 220/110 V
- Pris rasoir
- Cavo spiralato flessibile tra asciugacapelli / base a muro, lunghezza 60/120 cm
- Flexible cable between hair dryer / wall base, length 60/120 cm
- Cable a spirale entre support mural / sèche-cheveux, longueur 60/120 cm
- Cavo lineare di alimentazione con spina bipolare, lunghezza 90 cm
- Linear supply cable with plug, length 90 cm
- Cable linéaire d'alimentation avec prise bipolaire, longueur 90 cm



IP 21

ON/OFF

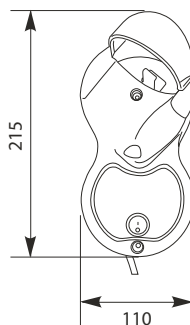

Profondità	Peso	
Depth 105 mm	Weight	0,850 Kg
Profondeur	Poids net	

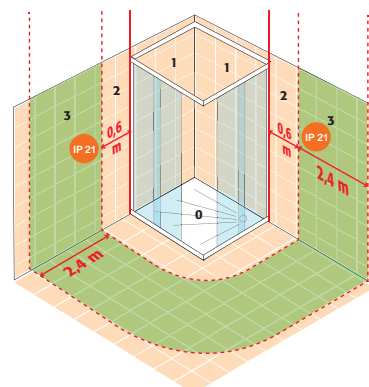

-  **ZONE D'INSTALLATION DE SÉCURITÉ VOLUME 3**
-  **Volume 3 = Area di sicurezza di installazione**
-  **Volume 3 = Safety installing area**

- Asciugacapelli e base a muro in ABS.
- 2 regolazioni di velocità aria / temperatura.
- Pulsante a rilascio di sicurezza.
- Interruttore on-off sulla base a muro e termostato di sicurezza.
- Cavo spiralato flessibile tra l'asciugacapelli e la base a muro, lunghezza 50 cm/120 cm.
- Cavo lineare di alimentazione con spina bipolare dalla base a muro, lunghezza 90 cm.

- ABS hair dryer with wall base.
- 2 heat / speed settings.
- Push-release button.
- ON - OFF safety switch button on wall-base. Overheating protection.
- Flexible cable between hair dryer/wall base, length 50 cm/120 cm.
- Linear supply cable with plug from wall base, length 90 cm.

- Le sèche-cheveux avec support mural en ABS.
- 2 réglages thermique / vitesse.
- Bouton d'activation de sécurité a pression.
- Interrupteur ON - OFF de sécurité sur la base murale.
- Cable a spirale entre le support mural et le sèche-cheveux, longueur 50 cm/120 cm.
- Cable linéaire d'alimentation avec prise bipolaire, longueur 90 cm.



### GARANZIA 2 ANNI • WARRANTY 2 YEARS • GARANTIE 2 ANS

#### CARATTERISTICHE TECNICHE / TECHNICAL FEATURES / CARACTÉRISTIQUES TECHNIQUES

Funzionamento	Pulsante a rilascio di sicurezza
Functioning	Push / release button
Activation	Bouton-poussoir de sécurité
Grado di protezione elettrica	
Electrical Protection Level	CLASS II
Isolation électrique	
Tensione	
Supply Voltage	220 V-240 V
Tension d'alimentation	
Potenza complessiva	2 velocità max. 1200 W
Power	2 speeds max. 1200 W
Puissance	2 vitesses max. 1200 W
Dimensioni A x L x P	
Dimensions H x W x D	150x91x147 (mm)
Dimensions H x L x P	
Frequenza	
Frequency	50-60 Hz
Fréquence	
Volume aria	
Air Flow	max.. 22,5 L/s
Débit d'air	
Peso	
Weight	0,650 Kg
Poids net	
Materiale	
Materials	ABS
Matériel	
Marchi di qualità	
Quality marks - certifications	CE RoHS
Certification	

Garanzia	2 anni
Warranty	2 years
Garantie	2 ans

#### Altre caratteristiche / Other features / Autres caractéristiques

Interruttore di sicurezza ON / OFF sulla base a muro
Termostato di sicurezza
Cavo estensibile
ON - OFF safety switch button on wall-base
Safety thermostat
Flexible cable
ON - OFF Interrupteur de sécurité sur la base mural
Thermostat de sécurité
Câble flexible

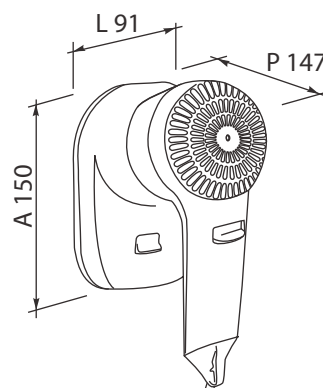



## VIENTO 2



**STESSE CARATTERISTICHE VIENTO 1 ECCETTO:  
SAME FEATURES AS VIENTO 1 EXCEPT:  
MÊMES CARACTÉRISTIQUES VIENTO 1, À L'EXCEPTION:**

Dimensioni A x L	
Dimensions H x W	193 x 200 x 102 mm
Dimensions H x L	
Peso	
Weight	0,650 Kg
Poids net	
Profondità (dal muro)	
Depth (wall-mounted)	102 mm
Profondeur (mur)	

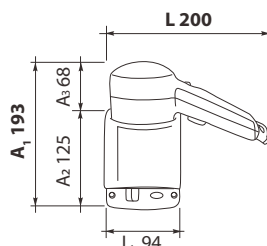

## VIENTO SHAVER



Dimensioni A x L	
Dimensions H x W	221 x 200 x 112 mm
Dimensions H x L	
Peso	
Weight	1,250 Kg
Poids net	
Profondità (dal muro)	
Depth (wall-mounted)	112 mm
Profondeur (mur)	
Preso rasoio	
Shaver socket	220 - 110 V
Pris rasoir	

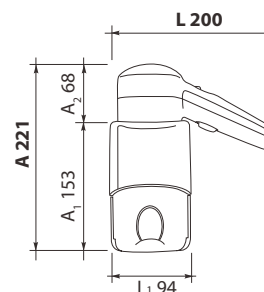

**PRESA RASOIO BIPOLARE 220-110V  
BIPOLAR 220-110V SHAVR SOCKET  
PRIS RASOIR BIPOLAIRE 220-110V**

## VIENTO SHAVER DA CASSETTO



- MURALE O DA CASSETTO
- WALL BASE OR DRAWER MODEL
- MODEL MURAL OU POUR TIROIR



Dimensioni A x L	
Dimensions H x W	204 x 182 mm
Dimensions H x L	
Peso	
Weight	0,850 Kg
Poids net	
Profondità (dal muro)/Altezza (cassetto)	
Depth (wall-mounted)/Height (drawer)	90 mm
Profondeur (mur)/Hautesse (tiroir)	
Preso rasoio	
Shaver socket	220 - 110 V
Pris rasoir	

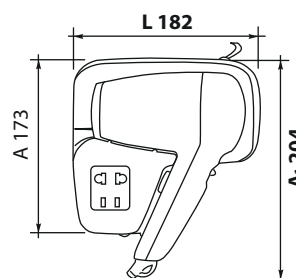

**PRESA RASOIO BIPOLARE 220-110V  
BIPOLAR 220-110V SHAVR SOCKET  
PRIS RASOIR BIPOLAIRE 220-110V**

## ASCIUGACAPELLI - HAIR DRYERS - SÈCHE-CHEVEUX

STESSE CARATTERISTICHE VIENTO 1 ECCETTO:  
 SAME FEATURES AS VIENTO 1 EXCEPT:  
 MÊMES CARACTÉRISTIQUES VIENTO 1, À L'EXCEPTION:

Dimensioni A x L	
Dimensions H x L	204 x 182 mm
Dimensions H x L	
Peso	
Weight	0,850 Kg
Poids net	
Profondità (dal muro)/Altezza (cassetto)	
Depth (wall-mounted)/Height (drawer)	90 mm
Profondeur (mur)/Hautesse ( tiroir)	
Interruttore differenziale salvavita con autodiagnosi	
Life saving system auto turn-off	
Interrupteur de sécurité coupe - circuit sur la base	

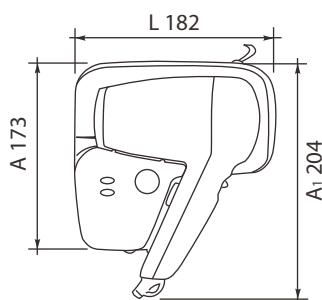

-  MURALE O DA CASSETTO
-  WALL BASE OR DRAWER MODEL
-  MODEL MURAL OU POUR TIROIR

**INTERRUTTORE DIFFERENZIALE SALVAVITA  
 CON AUTODIAGNOSI**

**LIFE SAVING SYSTEM AUTO TURN-OFF**

**INTERRUPTEUR DE SÉCURITÉ COUPE -  
 CIRCUIT SUR LA BASE**

Dimensioni A x L x P	
Dimensions H x W x D	182x 138 x 77 mm
Dimensions H x L x P	
Peso	
Weight	0,3 Kg
Poids net	

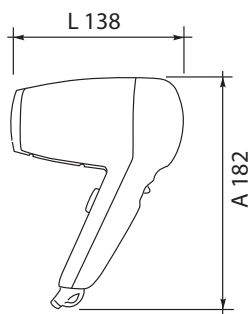

-  MODELLO DA CASSETTO
-  DRAWER MODEL
-  MODEL POUR TIROIR

**CAVO SPIRALATO 60 CM CON SPINA**

**60 CM FLEXIBLE CABLE WITH PLUG**

**CÂBLE FLEXIBLE 60 CM. AVEC PRISE**





-  SACCHETTO PORTA PHON (OPZIONALE)
-  HAIR DRYER BAG (OPTION)
-  SAC PORTE SÈCHE CHEVEUX (OPTIONNEL)



## ASCIUGACAPELLI- HAIR DRYERS - SÈCHE-CHEVEUX



-  - Motore a corrente alternata professionale
- 2 regolazioni separate di velocità aria e 3 di temperatura
- Attivazione con tasto on-off
- Tasto per colpo di aria fredda istantanea
- Potenza max. 1800 W
- Termostato sulla resistenza
- Disponibile in ABS colore nero
- **Cavo spiralato 0,5 mt. + cavo lineare 1,00 mt. con spina bipolare Italia**
- Disponibile con supporto murale universale in ABS nero (opzionale)

-  - **Powerful professional AC motor**
- 3 heat / 2 speed separate settings
- Cool shot button
- Max. power 1800 W
- Black ABS
- **Cable length 0,5 mt. (coiled) + 1,00 mt. (linear), with plug**
- Option: black ABS wall base, suitable for heavy traffic

-  - **Moteur AC professionnel longue durée de vie**
- 3 réglages thermique / 2 réglages de vitesse séparé
- Bouton pour coup froid
- Max. puissance 1800 W
- ABS noir
- **Longueur de câble jusqu'à 0,5 mt. (spirale) + 1,00 mt. (linéaire), avec prise bipolaire**
- Optionnel: support mural en ABS noir, idéal pour usage intensif



### GARANZIA 2 ANNI • WARRANTY 2 YEARS • GARANTIE 2 ANS

-  \* Per le limitazioni di garanzia si vedano le condizioni generali di servizio
-  \* Limited warranty. Please have a look to the General Warranty Conditions for details and consumables
-  \* Limitations de garantie: en revoir Conditions de Garantie Generale

#### CARATTERISTICHE TECNICHE TECHNICAL FEATURES / CARACTÉRISTIQUES TECHNIQUES

Funzionamento	Tasto ON/OFF
Functioning	ON/OFF switch
Activation	Bouton ON/OFF
Grado di protezione elettrica	
Electrical Protection Level	CLASS II
Isolation électrique	
Tensione	
Supply Voltage	220 V-240 V
Tension d'alimentation	
Potenza complessiva	max. 1800 W
Power	max. 1800 W
Puissance	max. 1800 W
Frequenza	
Frequency	50-60 Hz
Fréquence	
Volume aria	
Air Flow	max. 30,0 L/s
Débit d'air	
Peso	
Weight	0,500 Kg
Poids net	
Materiale	
Materials	ABS
Matériel	
Marchi di qualità	
Quality marks - certifications	CE RoHS
Certification	

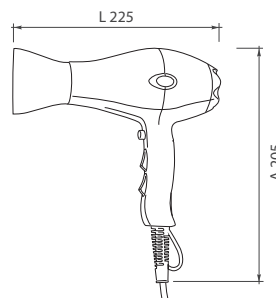

Dimensioni A x L x P	
Dimensions H x W x D	205 x 225 x 91 (mm)
Dimensions H x L x P	

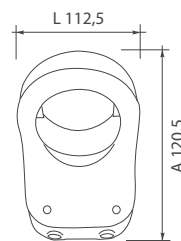

Dimensioni A x L x P	
Dimensions H x W x D	120,5 x 112,5 x 142,5 (Ø 64) mm
Dimensions H x L x P	
Peso	
Weight	0,175 Kg
Poids net	





ETERNITY  
CLASSIC



ETERNITY  
PLUG



ETERNITY  
SHAVER



## PROFESSIONALE NELLE PRESTAZIONI E NEL RISPARMIO ENERGETICO

**Motore a corrente alternata professionale.** 2 regolazioni per velocità aria / temperatura. Potenza max. 1300 W. Uscita d'aria con concentratore professionale. Filtro rimovibile.

**IL MASSIMO DELLA SICUREZZA:** attivazione con pulsante a pressione, spegnimento a rilascio, termostato sulla resistenza, interruttore on-off sulla base a muro.

**CLASSE & ELEGANZA:** Acciaio / ABS colore nero. Design vintage.

**VERSATILITÀ:** 3 versioni: con base a muro standard; con base a muro con presa rasoio; senza base a muro e con cavo lineare e spina.

## PROFESSIONAL & ENERGY SAVING HOTEL HAIR DRYER

**Powerful professional AC motor.** 2 heat / speed settings. Max. power 1300 W. Concentrator. Removable filter for cleaning.

**HIGH SAFETY LEVEL:** push button operating. Overheating protection. Wall-base ON-OFF switch.

**FIRST CLASS:** stainless steel & ABS. Vintage design.

**FLEXIBILITY:** available with standard wall-base; with shaver socket wall-base; without wall base and with linear cable.

## LE SÈCHE-CHEVEUX PROFESSIONNEL AVEC DES GRANDS ECONOMIE D'ENERGIE

**Moteur AC professionnel longue durée de vie.** 2 réglages thermique / vitesse. Puissance max 1300 W. Concentrateur. Filtre amovible pour le nettoyage.

**SÉCURITÉ MAXIMAL BOUTON PRESSION:** Thermostat de sécurité. Interrupteur ON-OFF sur le support mural.

**ELEGANCE:** acier ABS couleur noir.

**VERSATILITÉ:** disponible avec le support mural standard, avec une prise de rasoir, avec le câble linéaire.

## GARANZIA 2 ANNI\* • WARRANTY 2 YEARS\* • GARANTIE 2 ANS\*

*\* Per le limitazioni di garanzia si vedano le condizioni generali di servizio*

*\* Limited warranty. Please have a look to the General Warranty Conditions for details and consumables*

*\* Limitations de garantie: en revoir Conditions de Garantie Generale*

## ASCIUGACAPELLI - HAIR DRYERS - SÈCHE-CHEVEUX



### ETERNITY CLASSIC

Base a muro in ABS nero. Cavo a spirale tra la base a muro e il phon.  
Cavo di alimentazione lineare (1 mt.) con spina bipolare.

### ETERNITY SHAVER

Base a muro in ABS nero con presa rasoio 220 / 110 V. Cavo a spirale tra la base a muro e il phon. Cavo di alimentazione lineare (1 mt.) con spina bipolare.

### ETERNITY PLUG

Cavo lineare fino a 3 mt. con spina bipolare.  
(raccomandato per installazioni in palestre e spogliatoi)



### ETERNITY CLASSIC

ABS wall base, black colour. Coiled cable between wall base and hair dryer. Linear power supply cable (1 mt.) with plug.

### ETERNITY SHAVER

ABS wall base with 220 / 110 V shaver socket, black colour. Coiled cable between wall base and hair dryer. Linear power supply cable (1 mt.) with plug.

### ETERNITY PLUG

Linear cable up to 3 mt. with plug.  
(recommended for sport centers and changing rooms)



### ETERNITY CLASSIC

Support mural en abs noir. Cable a spirale entre le support mural et le sèche-cheveux. Cable linéaire d'alimentation (1 mt.) avec prise bipolaire.

### ETERNITY SHAVER

Support mural en abs noir avec prise rasoir 220 / 110 V. cable a spirale entre le support mural et le sèche-cheveux. Cable linéaire d'alimentation (1 mt.) avec prise bipolaire.

### ETERNITY PLUG

Cable linéaire jusqu'à 3 mètres avec prise bipolaire.  
(recommandé pour l'installation dans les gymnases et les vestiaires)

### CARATTERISTICHE TECNICHE TECHNICAL FEATURES / CARACTÉRISTIQUES TECHNIQUES

Funzionamento	Pulsante a rilascio
Functioning	Push / release button
Activation	Bouton-poussoir
Grado di protezione elettrica	
Electrical Protection Level	CLASS II
Isolation électrique	
Tensione	
Supply Voltage	220 V-240 V
Tension d'alimentation	
Potenza complessiva	2 velocità max. 1300 W
Power	2 speeds max. 1300 W
Puissance	2 vitesses max. 1300 W
Dimensioni A x L x P	218 x 260 x 90 (mm) <b>PLUG</b>
Dimensions H x W x D	295 x 218 x 145 (mm) <b>SHAVER</b>
Dimensions H x L x P	260 x 218 x 110 (mm) <b>CLASSIC</b>
Frequenza	
Frequency	50-60 Hz
Fréquence	
Volume aria	
Air Flow	max. 30,0 L/s
Débit d'air	
Peso	
Weight	0,800 Kg
Poids net	
Materiale	Acciaio / ABS
Materials	Stainless steel / ABS
Matériel	Acier / ABS
Marchi di qualità	
Quality marks - certifications	CE RoHS
Certification	

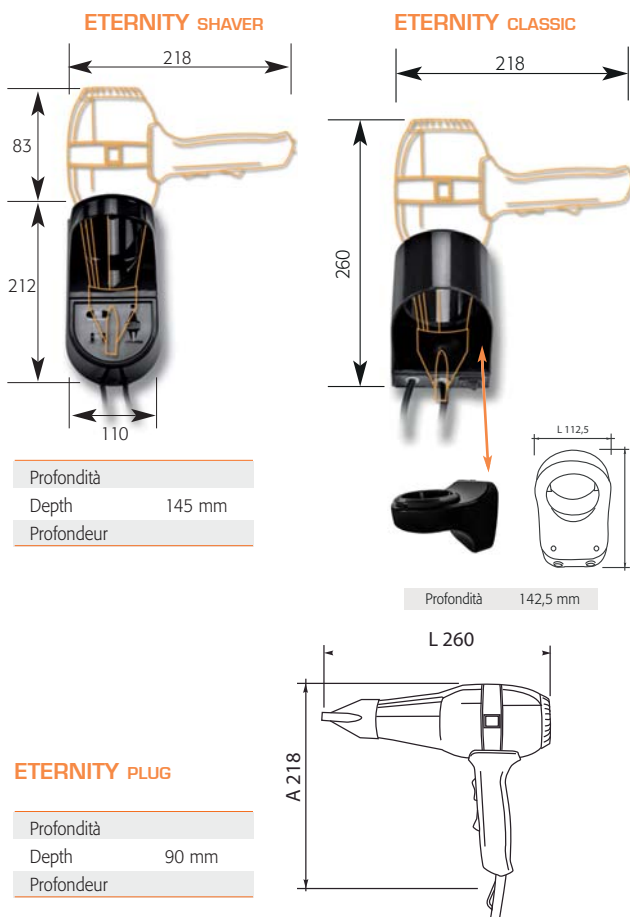



**FIT PHON**  
BIANCO

**FIT PHON**  
NERO

**ANELLO PER FISSAGGIO A MURO  
CON BLOCCA CAVO  
WALL MOUNTING RING  
WITH CABLE LOCK  
BAGUE POUR MONTAGE MURAL**

**L'ECCELLENZA DELLA PERFORMANCE:** motore a corrente alternata professionale.  
Regolazioni multiple combinabili: 2 per velocità aria, 3 per temperatura.  
Potenza standard max. 1800 W (USO HOTEL)  
Disponibile anche nella versione a risparmio energetico max. 1000 W (USO COMUNITARIO)  
Filtro rimovibile.

**IL MASSIMO DELLA SICUREZZA:** attivazione con pulsante a pressione, spegnimento a rilascio, termostato sulla resistenza.

**L'ELEGANZA:** disponibile in 2 versioni, ABS colore bianco e ABS nero.

Design ergonomico e contemporaneo.  
Disponibile con supporto a muro in ottone cromato (opzionale).

**LA PRATICITÀ:** grande comodità d'uso grazie al cavo spiralato 0,5 mt. + cavo lineare 1,5 mt.  
**DIFFUSORE PROFESSIONALE INCLUSO**

**HIGH PERFORMANCE:** powerful professional AC motor.  
3 heat and 2 speed settings.  
Standard max. power 1800 W (HOTEL ONLY)  
Available also in 1000 W version (LOCKER ROOM)  
Removable filter for cleaning.

**HIGH SAFETY LEVEL:** push button operating. Overheating protection.

**ELEGANT:** available in white & black colour. Ergonomic & contemporary design.  
Available with chrome brass holder (wall mounted).

**EASY TO USE:** Cable length 0,5 mt. (coiled) + 1,5 mt. (linear).

**PROFESSIONAL CONCENTRATOR INCLUDED**

**EXCELLENCE DE LA PERFORMANCE:** moteur AC professionnel longue durée de vie.  
3 réglages thermique et 2 réglages de vitesse.  
Puissance standard max 1800 W (HOTEL)  
Aussi disponible en la version 1000 W (VESTIAIRE)  
Filtre amovible pour le nettoyage.

**SÉCURITÉ MAXIMALE:** bouton pression, thermostat de sécurité.

**ELEGANT:** ABS blanc ou noir. Disponible avec le bague pour montage mural.

**FACILE À UTILISER:** longueur de câble jusqu'à 0,5 mt. (spirale) + 1,5 mt. (linéaire).

**CONCENTRATEUR PROFESSIONNEL INCLUS**



**GARANZIA 2 ANNI • WARRANTY 2 YEARS • GARANTIE 2 ANS**



**🇮🇹** \* Per le limitazioni di garanzia si vedano le condizioni generali di servizio



**🇬🇧** \* Limited warranty. Please have a look to the General Warranty Conditions for details and consumables

**🇫🇷** \* Limitations de garantie: en revoir Conditions de Garantie Generale





### ASCIUGACAPELLI - HAIR DRYERS - SÈCHE-CHEVEUX



Cod.	Materiale Materials Matériel	Regolazioni velocità Speed settings Réglages de vitesse	Regolazioni temp. Heat settings Réglages thermique	Destinazione d'uso / supporto Recommended usage & wall base Utilisation recommandée / support
<b>FIT PHON BIANCO 1800W</b>	ABS Bianco / White / Blanc	2	3	HOTEL 
<b>FIT PHON NERO 1800W</b>	ABS nero / black / noir	2	3	
<b>FIT PHON BIANCO 1000W</b>	ABS Bianco / White / Blanc	2	2	SPOGLIATOIO LOCKER ROOM VESTIAIRE 
<b>FIT PHON NERO 1000W</b>	ABS nero / black / noir	2	2	

-  Cavo a spirale 0,5 mt. + cavo lineare 1,5 mt. con spina bipolare.
-  Cable length 0,5 mt. (coiled) + 1,5 mt (linear) with plug.
-  Longueur de cable 0,5 mt. (spirale) + 1,5 mt. (linéaire) avec prise bipolaire.



-  **SUPPORTO AD ANELLO PER FISSAGGIO A MURO (OPZIONALE)**  
Supporto murale in ottone cromato, con blocca cavo all'interno del supporto, **ideale in hotel.**
-  **CHROME BRASS HOLDER (OPZIONALE)**  
Ready for wall mounting with inside cable locking, **recommended for hotel.**
-  **SUPPORT MURAL PUR LE SÈCHE-CHEVEUX (OPTIONNEL)**  
Support mural chromé, avec fixage antivol du cable, **pour hotel.**



-  **SUPPORTO PHON UNIVERSALE (OPZIONALE)**  
Base murale in ABS nero, con blocca cavo all'interno del supporto, **ideale per uso comunitario.**
-  **BLACK ABS WALL BASE (OPTION)**  
Cable Locking inside, **recommended for heavy traffic.**
-  **SUPPORT MURAL EN ABS (OPTIONNEL)**  
Support mural en ABS noir, avec fixage antivol du cable, **pour usage intensif.**



#### CARATTERISTICHE TECNICHE TECHNICAL FEATURES / CARACTÉRISTIQUES TECHNIQUES

Funzionamento	Pulsante a rilascio
Functioning	Push / release button
Activation	Bouton-poussoir
Grado di protezione elettrica	
Electrical Protection Level	CLASS II
Isolation électrique	
Tensione	
Supply Voltage	220 V-240 V
Tension d'alimentation	
Potenza	1800 W (3 regolaz.) - 1000 W (2 regolaz.)
Power	1800 W (3 settings) - 1000 W (2 settings)
Puissance	1800 W (3 réglages) - 1000 W (2 réglages)
Frequenza	
Frequency	50-60 Hz
Fréquence	
Volume aria	
Air Flow	max. 30,0 L/s
Débit d'air	
Peso	
Weight	0,900 Kg
Poids net	
Materiale	
Materials	ABS
Matériel	
Marchi di qualità	
Quality marks - certifications	CE RoHs
Certification	
Garanzia	2 anni
Warranty	2 years
Garantie	2 ans

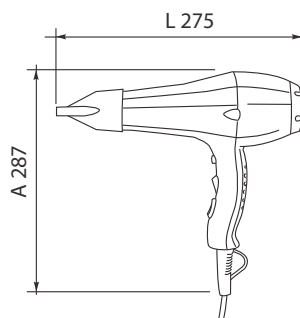

Dimensioni A x L x P	
Dimensions H x W x D	287 x 275 x 95 (mm)
Dimensions H x L x P	

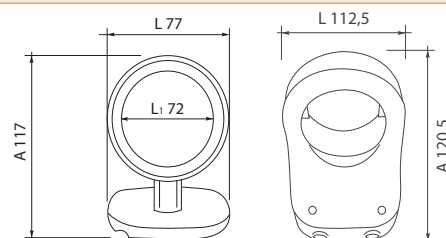

Profondità (dal muro)		
Depth (wall-mounted)	118 mm	142,5 mm
Profondeur (mur)		
Dimensioni A x L		
Dimensions H x W	117 x 77 (Ø 72) mm	120,5 x 112,5 (Ø 64) mm
Dimensions H x L		
Peso		
Weight	0,165 Kg	0,175 Kg
Poids net		

## ASCIUGACAPELLI - HAIR DRYERS - SÈCHE-CHEVEUX

**IL PIÙ PICCOLO PHON CON TUBO ESISTENTE!  
THE SMALLEST EXISTING HAIR DRYER WITH HOSE!  
LE PLUS PETIT SÈCHE CHEVEUX AVEC TUBE!**

-  - Asciugacapelli a parete in ABS con tubo flessibile e presa rasoio laterale 220 V – 110 V
  - **Motore a corrente alternata professionale**
  - 2 regolazioni di velocità aria / temperatura, max. 700 W
  - Attivazione automatica quando si sgancia il tubo
  - Autospegnimento dopo 5 min. in caso di mancato riaggancio del tubo
  - Termostato di sicurezza
-  - Wall mounted ABS hair dryer with flexible hose and shaver socket 220 V – 110 V
  - **Professional AC motor**
  - 2 heat / speed settings, max. 700 W
  - Auto turn-on when hose is released
  - Auto turn off after 5 min.
  - Overheating protection.
-  - Sèche-cheveux mural en ABS avec tube extensible et prise de rasoir 220V - 110V
  - **Moteur AC professionnel**
  - 2 vitesses, max. 700 W
  - Arrêt automatique (auto-timer): au bout de 5 minutes en cas de non repositionnement du tube
  - Thermostat de sécurité



**GARANZIA 2 ANNI\* • WARRANTY 2 YEARS\* • GARANTIE 2 ANS\***

## CARATTERISTICHE TECNICHE / TECHNICAL FEATURES / CARACTÉRISTIQUES TECHNIQUES

Funzionamento	Allo sganciamento del tubo	Garanzia	2 anni
Functioning	Auto turn-on when hose is released	Warranty	2 years
Activation	Automatique a la poigné	Garantie	2 ans
Grado di protezione elettrica			
Electrical Protection Level	CLASS II		
Isolation électrique			
Tensione			
Supply Voltage	220 V-240 V		
Tension d'alimentation			
Potenza 2 velocità			
Power 2 Speeds	400W, 700W		
Puissance 2 Vitesse			
Dimensioni A x L x P	177(517 con tubo)x140x93 mm		
Dimensions H x W x D	177(517 with hose)x140x93 mm		
Dimensions H x L x P	177(517 avec tube)x140x93 mm		
Frequenza			
Frequency	50-60 Hz		
Fréquence			
Volume aria			
Air Flow	max. 30,0 L/s		
Débit d'air			
Peso			
Weight	1,3 Kg		
Poids net			
Materiale			
Materials	ABS		
Matériel			
Marchi di qualità			
Quality marks - certifications	CE RoHs		
Certification			

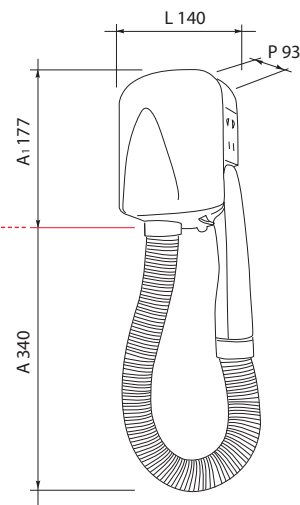



**ALTEZZA DAL SUOLO: 1,55 MT.  
FLOOR HEIGHT: 1,55 MT.  
POSITIONNEMENT À 1,55 MT. DU SOL**

 \* Per le limitazioni di garanzia si vedano le condizioni generali di servizio

 \* Limited warranty. Please have a look to the General Warranty Conditions for details and consumables

 \* Limitations de garantie: en voir Conditions de Garantie Generale

## ASCIUGACAPELLI - HAIR DRYERS - SÈCHE-CHEVEUX

-  - Asciugacapelli a parete in ABS con tubo flessibile e presa rasoio frontale 220 V
  - 3 regolazioni di velocità aria / temperatura, max. 1000 W
  - Attivazione automatica quando si sgancia il tubo
  - Autospegnimento dopo 10 min. in caso di mancato riaggancio del tubo
  - Termostato di sicurezza
-  - Wall mounted ABS hair dryer with flexible hose and shaver socket 220 V
  - 3 heat / speed settings, max. 1000 W
  - Auto turn-on when hose is released
  - Auto turn off after 10 min.
  - Overheating protection.
-  - Sèche-cheveux mural en ABS avec tube extensible et prise de rasoir 220V
  - 3 vitesses, max. 1000 W
  - Arrêt automatique (auto-timer): au bout de 10 minutes en cas de non repositionnement du tube
  - Thermostat de sécurité

**NO USO COLLETTIVO  
NO HEAVY TRAFFIC  
NO PASSAGE ÉLEVÉE**



**GARANZIA 2 ANNI • WARRANTY 2 YEARS • GARANTIE 2 ANS**

**CARATTERISTICHE TECNICHE / TECHNICAL FEATURES / CARACTÉRISTIQUES TECHNIQUES**

Funzionamento	Allo sganciamento del tubo	Garanzia	2 anni
Functioning	Auto turn-on when hose is released	Warranty	2 years
Activation	Automatique a la poigné	Garantie	2 ans
Grado di protezione elettrica			
Electrical Protection Level	CLASS II		
Isolation électrique			
Tensione			
Supply Voltage	220 V-240 V		
Tension d'alimentation			
Potenza 3 velocità			
Power 3 Speeds	400W, 700W, 1000W		
Puissance 3 Vitesse			
Dimensioni A x L x P	250(590 con tubo)x184x117 mm		
Dimensions H x W x D	250(590 with hose)x184x117 mm		
Dimensions H x L x P	250(590 avec tube)x184x117 mm		
Frequenza			
Frequency	50-60 Hz		
Fréquence			
Volume aria			
Air Flow	max. 18,0 L/s		
Débit d'air			
Peso			
Weight	2,300 Kg		
Poids net			
Materiale			
Materials	ABS		
Matériel			
Marchi di qualità			
Quality marks - certifications	CE RoHS		
Certification			

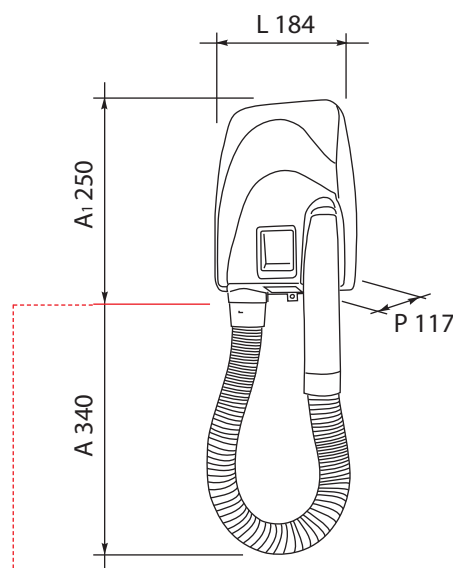

**ALTEZZA DAL SUOLO: 1,55 MT.**

**FLOOR HEIGHT: 1,55 MT.**

**POSITIONNEMENT À 1,55 MT. DU SOL**



 \* Per le limitazioni di garanzia si vedano le condizioni generali di servizio

 \* Limited warranty. Please have a look to the General Warranty Conditions for details and consumables



 \* Limitations de garantie: en revoir Conditions de Garantie Generale





-  - Gamma completa elegante di alta qualità
  - Ottone cromato
  - Facile montaggio e manutenzione
  - Viteria Inox fornita
-  - A range of high quality and modern design accessories
  - Made of chrome plated brass
  - Easy to install and maintenance
  - Stainless steel screws (included)
-  - Gamme de conception moderne de haute qualité
  - Matériau en laiton chromé
  - Facile à installer et à entretenir
  - Vis en acier inoxydable (incluses)



-  Porta biancheria
-  Bath towels shelf
-  Etendoir

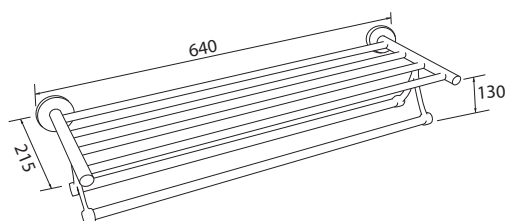

#### CARATTERISTICHE TECNICHE TECHNICAL FEATURES / CARACTÉRISTIQUES TECHNIQUES

Cod.	Lunghezza Lenght Longueur	Larghezza Width Largeur	Altezza Height Hauteur
4018	640	215	130

Peso/Weight/Poids: 1,16 Kg

LINEA HOTEL - HOTEL LINE - LIGNE HOTEL



- Porta asciugamani doppio
- Towel holder double bar
- Porte-serviettes double

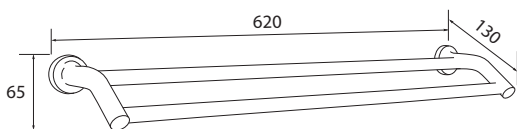

**CARATTERISTICHE TECNICHE**  
**TECHNICAL FEATURES / CARACTÉRISTIQUES TECHNIQUES**

Cod.	Lunghezza Lenght Longueur	Larghezza Width Largeur	Altezza Height Hauteur
4025	620	130	65

Peso/Weight/Poids: 0,58 Kg



- Porta asciugamani singolo 620 mm
- Towel holder single bar 620 mm
- Porte-serviettes 620 mm

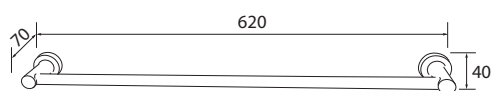

**CARATTERISTICHE TECNICHE**  
**TECHNICAL FEATURES / CARACTÉRISTIQUES TECHNIQUES**

Cod.	Lunghezza Lenght Longueur	Larghezza Width Largeur	Altezza Height Hauteur
4032	620	70	40

Peso/Weight/Poids: 0,22 Kg



- Porta asciugamani singolo 450 mm
- Towel holder single bar 450 mm
- Porte-serviettes 450 mm

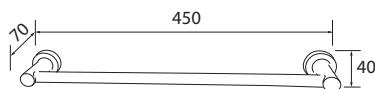

**CARATTERISTICHE TECNICHE**  
**TECHNICAL FEATURES / CARACTÉRISTIQUES TECHNIQUES**

Cod.	Lunghezza Lenght Longueur	Larghezza Width Largeur	Altezza Height Hauteur
4049	450	70	40

Peso/Weight/Poids: 0,20 Kg



- Porta asciugamani singolo 320 mm
- Towel holder single bar 320 mm
- Porte-serviettes 320 mm

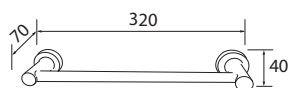



**CARATTERISTICHE TECNICHE**  
**TECHNICAL FEATURES / CARACTÉRISTIQUES TECHNIQUES**

Cod.	Lunghezza Lenght Longueur	Larghezza Width Largeur	Altezza Height Hauteur
4056	320	70	40

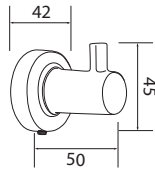
Peso/Weight/Poids: 0,28 Kg







-  Appendiabito 1 gancio
-  1 heads bath robe hanger
-  Portemanteau 1 crochet

**CARATTERISTICHE TECNICHE**  
**TECHNICAL FEATURES / CARACTÉRISTIQUES TECHNIQUES**

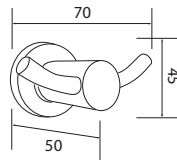
Cod.	Lunghezza Lenght Longueur	Larghezza Width Largeur	Altezza Height Hauteur
4063	42	50	45

Peso/Weight/Poids: 0,06 Kg







-  Appendiabito 2 ganci
-  2 heads bath robe hanger
-  Portemanteau 2 crochets

**CARATTERISTICHE TECNICHE**  
**TECHNICAL FEATURES / CARACTÉRISTIQUES TECHNIQUES**

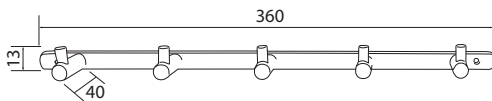
Cod.	Lunghezza Lenght Longueur	Larghezza Width Largeur	Altezza Height Hauteur
4070	70	50	45

Peso/Weight/Poids: 0,12 Kg







-  Appendiabito 5 ganci
-  5 heads bath robe hanger
-  Portemanteau 5 crochets

**CARATTERISTICHE TECNICHE**  
**TECHNICAL FEATURES / CARACTÉRISTIQUES TECHNIQUES**

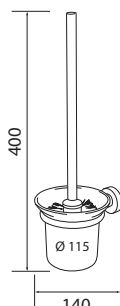
Cod.	Lunghezza Lenght Longueur	Larghezza Width Largeur	Altezza Height Hauteur
4087	360	40	13

Peso/Weight/Poids: 0,34 Kg



-  Portascopino in vetro
-  Glass toilet brush holder
-  Porte-balais wc en verre

**CARATTERISTICHE TECNICHE**  
**TECHNICAL FEATURES / CARACTÉRISTIQUES TECHNIQUES**

Cod.	Lunghezza Lenght Longueur	Larghezza Width Largeur	Altezza Height Hauteur
4094	Ø 115	140	400

Peso/Weight/Poids: 0,46 Kg



LINEA HOTEL - HOTEL LINE - LIGNE HOTEL

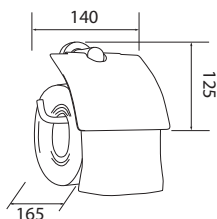

- Porta rotolo
- Toilet paper holder
- Porte-rouleau

**CARATTERISTICHE TECNICHE**  
**TECHNICAL FEATURES / CARACTÉRISTIQUES TECHNIQUES**

Cod.	Lunghezza Lenght Longueur	Larghezza Width Largeur	Altezza Height Hauteur
4100	140	165	125

Peso/Weight/Poids: 0,22 Kg

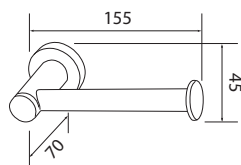

- Porta rotolo di riserva
- Spare toilet roll holder
- Porte-rouleau de rechange

**CARATTERISTICHE TECNICHE**  
**TECHNICAL FEATURES / CARACTÉRISTIQUES TECHNIQUES**

Cod.	Lunghezza Lenght Longueur	Larghezza Width Largeur	Altezza Height Hauteur
4117	155	70	45

Peso/Weight/Poids: 0,14 Kg

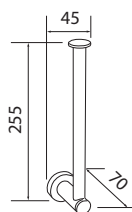

- Porta rotolo di riserva doppio
- Spare toilet roll holder double
- Porte-rouleau de rechange double

**CARATTERISTICHE TECNICHE**  
**TECHNICAL FEATURES / CARACTÉRISTIQUES TECHNIQUES**

Cod.	Lunghezza Lenght Longueur	Larghezza Width Largeur	Altezza Height Hauteur
4124	45	70	255

Peso/Weight/Poids: 0,16 Kg

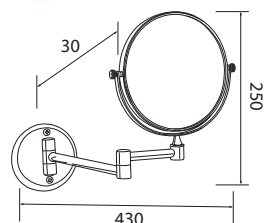





- Specchio con lente Ø 200 mm, ingrandimento 3x
- Mirror with lens Ø 200 mm, 3x magnifying factor
- Miroir avec lens Ø 200 mm, grossissement 3x

**CARATTERISTICHE TECNICHE**  
**TECHNICAL FEATURES / CARACTÉRISTIQUES TECHNIQUES**

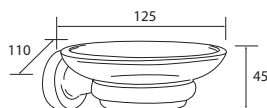
Cod.	Lunghezza Lenght Longueur	Larghezza Width Largeur	Altezza Height Hauteur
4131	430	30	250

Peso/Weight/Poids: 0,68 Kg







-  Porta sapone con piatto in vetro
-  Soap dish
-  Porte-savon avec plat en verre

**CARATTERISTICHE TECNICHE**  
**TECHNICAL FEATURES / CARACTÉRISTIQUES TECHNIQUES**

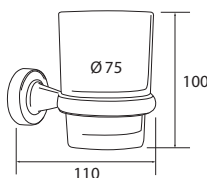
Cod.	Lunghezza Lenght Longueur	Larghezza Width Largeur	Altezza Height Hauteur
4148	110	125	45

Peso/Weight/Poids: 0,35 Kg







-  Porta bicchiere
-  Toilet glass holder
-  Porte-verre

**CARATTERISTICHE TECNICHE**  
**TECHNICAL FEATURES / CARACTÉRISTIQUES TECHNIQUES**

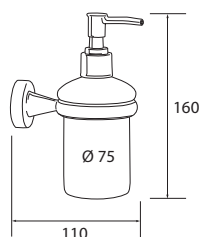
Cod.	Lunghezza Lenght Longueur	Larghezza Width Largeur	Altezza Height Hauteur
4155	Ø 75	110	100

Peso/Weight/Poids: 0,28 Kg







-  Porta sapone liquido
-  Liquid soap holder
-  Porte-savon liquide

**CARATTERISTICHE TECNICHE**  
**TECHNICAL FEATURES / CARACTÉRISTIQUES TECHNIQUES**

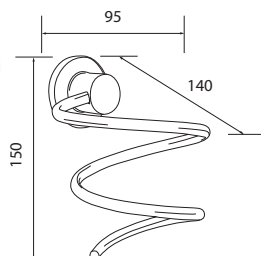
Cod.	Lunghezza Lenght Longueur	Larghezza Width Largeur	Altezza Height Hauteur
4162	Ø 75	110	160

Peso/Weight/Poids: 0,30 Kg



-  Supporto phon universale a muro
-  Hair dryer universal holder
-  Support mural sèche cheveux universel



**CARATTERISTICHE TECNICHE**  
**TECHNICAL FEATURES / CARACTÉRISTIQUES TECHNIQUES**

Cod.	Lunghezza Lenght Longueur	Larghezza Width Largeur	Altezza Height Hauteur
4179	95	140	150

Peso/Weight/Poids: 0,22 Kg

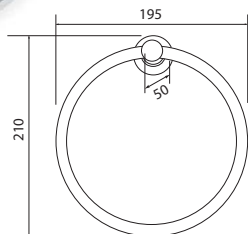
LINEA HOTEL - HOTEL LINE - LIGNE HOTEL







-  Porta asciugamani ad anello
-  Towel ring
-  Anneau porte-serviette

**CARATTERISTICHE TECNICHE**  
**TECHNICAL FEATURES / CARACTÉRISTIQUES TECHNIQUES**

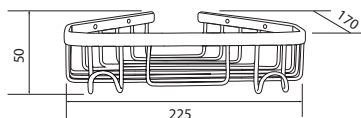
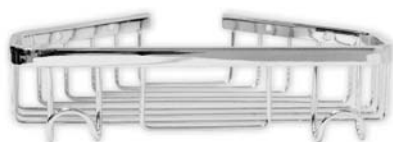
Cod.	Lunghezza Lenght Longueur	Larghezza Width Largeur	Altezza Height Hauteur
4186	195	50	210

Peso/Weight/Poids: 0,12 Kg







-  Porta sapone angolare
-  Angle shelf
-  Porte-savon angulaire

**CARATTERISTICHE TECNICHE**  
**TECHNICAL FEATURES / CARACTÉRISTIQUES TECHNIQUES**

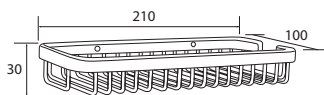
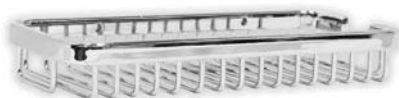
Cod.	Lunghezza Lenght Longueur	Larghezza Width Largeur	Altezza Height Hauteur
4193	225	170	50

Peso/Weight/Poids: 0,48 Kg







-  Porta sapone a filo
-  Soap dish
-  Porte-savon

**CARATTERISTICHE TECNICHE**  
**TECHNICAL FEATURES / CARACTÉRISTIQUES TECHNIQUES**

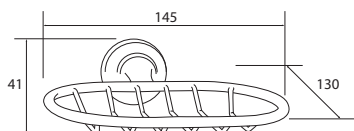
Cod.	Lunghezza Lenght Longueur	Larghezza Width Largeur	Altezza Height Hauteur
4209	210	100	30

Peso/Weight/Poids: 0,40 Kg



-  Porta sapone
-  Soap dish
-  Porte-savon

**CARATTERISTICHE TECNICHE**  
**TECHNICAL FEATURES / CARACTÉRISTIQUES TECHNIQUES**

Cod.	Lunghezza Lenght Longueur	Larghezza Width Largeur	Altezza Height Hauteur
4216	145	130	41

Peso/Weight/Poids: 0,14 Kg



# CASSEFORTI / SAFE BOX / COFFRE FORT

LINEA HOTEL - HOTEL LINE - LIGNE HOTEL

## VAMASAFE BASIC

**CASSAFORTE** Mod. 3745 / 3752

**SAFE BOX** Mod. 3745 / 3752

**COFFRE FORT** Mod. 3745 / 3752



Mod. 3745



LAPTOP 15"

Mod. 3752

Dimensioni esterne A x L x P Dimensions external H x W x D Dimensions externe H x L x P	<b>mod. 3745:</b> 200 x 310 x 200 (mm) <b>mod. 3752:</b> 200 x 410 x 410 (mm)
Dimensioni interne A x L x P Dimensions internal H x W x D Dimensions interne H x L x P	<b>mod. 3745:</b> 190 x 300 x 150 (mm) <b>mod. 3752:</b> 195 x 405 x 350 (mm)
Peso Weight Poids net	<b>mod. 3745:</b> 7,5 Kg <b>mod. 3752:</b> 14,5 Kg
Volume Volume Volume	<b>mod. 3745:</b> 9,5 lt <b>mod. 3752:</b> 27 lt

## CARATTERISTICHE / FEATURES / CARACTÉRISTIQUES

Serratura elettronica digitale
Digital electronic lock
Serrure électronique numérique
Spessore della porta 3 mm
Thickness of door 3 mm
Épaisseur de la porte de 3 mm
Spessore delle pareti 2 mm
Thickness of walls 2 mm
Épaisseur des murs de 2 mm
Serratura elettronica digitale con memoria permanente
Digital electronic lock with permanent memory
Numerique serrure électronique avec une mémoire permanente
Segnalazioni visive e sonore sul display a LED ad alto contrasto cromatico
Visual and acoustic signalling by means of leds and buzzer
Signalisation visuels et sonores par des moyens de LED-et buzzer
Codice Master cambiabile ad uso dell'albergatore
Changeable master code and emergency key override for the Hotel Management
Code maître modifiable et clé de dérivation d'urgence pour la gestion Hôtel
Serratura di emergenza con chiave ad uso dell'albergatore
Emergency mechanical key
Verrouillage d'urgence et la clé pour une utilisation par Hotelier
Batterie escluse
Batteries not included
Piles non incluses
Fori di ancoraggio sulla base e sullo schienale (2+2)
Fixing holes on back and base (2+2)
Les trous de fixation sur le dos et la base (2+2)
Tasselli per fissaggio inclusi
Expansion bolts included
Chevilles pour fixation inclus
Tappetino interno
Cover carpet provided
Tapis intérieur
Verniciatura in polvere termoidurente colore grigio
Powder coated finish, grey colour
Revêtement en poudre finition en gris

## VAMASAFE LASERTOP

**CASSAFORTE A MOBILE** MOD. 4339 / 4346

**SAFE BOX** MOD. 4339 / 4346

**COFFRE FORT** MOD. 4339 / 4346



Luce interna  
Interior lighting  
Éclairage intérieur

Serratura motorizzata e taglio laser  
Motorized locking system and laser cut  
Serrure motorisée et coupe laser

### LAPTOP 15" (mod. 4346)

Art.	Dimensioni esterne / external dimensions			Dimensioni imballo / Box dimensions			Peso
	Alt. (H)	Largh. (W)	Prof. (D)	Alt. (H)	Largh. (W)	Prof. (D)	
<b>4339</b>	180	280	200	215	310	270	7 Kg.
<b>4346</b>	200	420	370	235	465	435	11 Kg.

## CARATTERISTICHE / FEATURES / CARACTÉRISTIQUES

Serratura elettronica digitale motorizzata
Digital motorized electronic lock
Serrure électronique numérique motorisée
Spessore della porta 5 mm
Thickness of door 5 mm
Épaisseur de la porte de 5 mm
Spessore delle pareti di 2 mm
Thickness of walls 2 mm
Épaisseur des murs de 2 mm
Segnalazioni visive e sonore sul display a LED ad alto contrasto cromatico
Visual signalling on high contrast LED's display
Signalisation visuels et sonores par des moyens de LED-et buzzer
Visualizzazione a display degli ultimi 100 eventi
Audit trail to know the last 100 events from display
Visualisation dernière 100 events
Codice Master cambiabile ad uso dell'albergatore
Changeable master code and emergency key override for the Hotel Management
Code maître modifiable et clé de dérivation d'urgence pour la gestion Hôtel
Serratura di emergenza con chiave ad uso dell'albergatore
Emergency lock and key for use of the hotelier
Verrouillage d'urgence et la clé pour une utilisation par Hotelier
Batterie incluse
Batteries included
Piles fournies
Fori di ancoraggio sulla base e sullo schienale (2+2)
Fixing holes on back and base (2+2)
Les trous de fixation sur le dos et la base (2+2)
Tasselli per fissaggio inclusi
Expansion bolts included
Chevilles pour fixation inclus
Tappetino e illuminazione LED interni
Cover carpet provided, interior LED lighting
Tapis et éclairage intérieur LED
Verniciatura in polvere termoidurente colore nero
Powder coated finish, black
Revêtement en poudre finition en noir



**Murale**  
**Wall mounted**  
**Mural**

**PORTASCOPINO MURALE**

- Acciaio inox
- Fissaggio murale in 3 punti
- Bacinella di recupero in plastica
- Viteria inclusa

**TOILET BRUSH WALL MOUNTED**

- Stainless steel
- Wall mounting support in 3 points
- Plastic inner bucket to ensure tightness and facilitate cleaning
- Screws included

**PORTE-BALAIS WC MURAL**

- Acier inoxydable
- Le montage mural en 3 points
- Bac de récupération de plastique
- Vis incluses

**3 lt**



**5 lt**



**12 lt**



**PATTUMIERE A PEDALE IN METALLO 3/5/12 LT**

- Acciaio inox, con base in ABS
- Maniglia per facilitare lo svuotamento
- Secchio interno in plastica con maniglia

**METAL PEDAL BINS 3/5/12 LT**

- Stainless Steel, with ABS base
- Metal handle for easy access
- Plastic inside bucket with metal handle

**POUBELLES PEDALE METAL 3/5/12 LT**

- En acier inoxydable avec base en ABS
- Poignée pour faciliter la vidange
- Seau en plastique avec poignée intérieure



**BOLLITORE ELETTRICO PLEASURE**

Bollitore d'acqua elettrico in acciaio inox per hotel. Capacità max. 1,2 litri. Spegnimento automatico al raggiungimento della temperatura di ebollizione. Indicatore funzionamento luminoso.

**ELECTRIC KETTLE PLEASURE**

Kettle in stainless steel for hotels. Capacity max. 1.2 liters. Auto power-off at boiling temperature. Operation indicator.

**BOUILLLOIRE ELECTRIQUE PLEASURE**



Bouilloire en acier inoxydable pour les hôtels. Capacité max. 1,2 litres. Mise hors tension automatique à la réalisation des la température d'ébullition. Voyant de fonctionnement lumineux.

**CARATTERISTICHE TECNICHE**  
**TECHNICAL FEATURES / CARACTÉRISTIQUES TECHNIQUES**

Tensione	
Supply Voltage	220 V-240 V
Tension d'alimentation	
Grado di protezione elettrica	
Electrical Protection Level	CLASS I
Isolation électrique	
Frequenza	
Frequency	50-60 Hz
Fréquence	
Potenza	
Power	1500 W
Puissance	
Garanzia	2 anni
Warranty	2 years
Garantie	2 ans
Lunghezza cavo alimentazione 90 cm, con spina shuko	
90 cm power supply cable, with shuko plug	
Longueur du cable 90 cm, avec fiche shuko	

# MINIBAR

LINEA HOTEL - HOTEL LINE - LIGNE HOTEL

-  MINIBAR CLASSE ENERGETICA A+
-  MINIBAR ENERGY CLASS A+
-  MINIBAR CLASSE ÉNERGETIQUE A+



**GARANZIA 2 ANNI • WARRANTY 2 YEARS • GARANTIE 2 ANS**

-  - Da incasso o libera installazione
- Termostato elettronico
- Sbrinamento automatico
- Luce interna a LED basso consumo
- Porta reversibile
- Contiene bottiglie da 1 lt. e 1,5 lt. \*
- Gancio traino porta
- Refrigerante R600a
- **SILENZIOSITA' TOTALE CERTIFICATA SGS**

-  - Built-in / free standing
- Electronic thermostat
- Electronic autodefrost
- Low consumption LED inside
- Reversible door
- Suitable for 1lt. and 1,5 lt. bottles \*
- Sliding hinge fixture
- R600a cooler
- **COMPLETELY NOISELESS, CERTIFIED by SGS**

-  - Installation encastrée ou libre
- Thermostat électronique
- Dégivrage automatique
- Éclairage intérieur à LED
- Porte réversible
- Contient des bouteilles de 1 lt. et 1,5 lt. \*
- Crochet d'entraînement
- R600a réfrigérant
- **TOTALEMENT SILENCIEUX CERTIFIÉ par SGS**

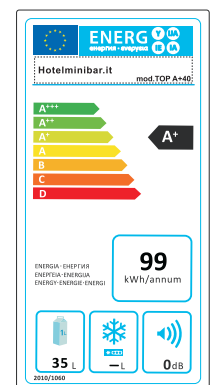
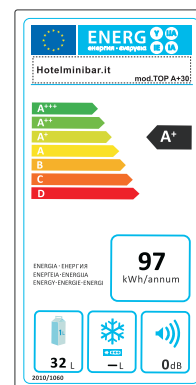
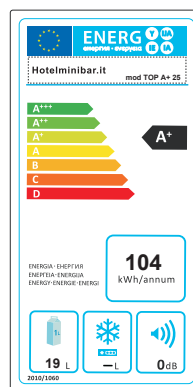



# MINIBAR

LINEA HOTEL - HOTEL LINE - LIGNE HOTEL

## TOP A+ 25 LT.

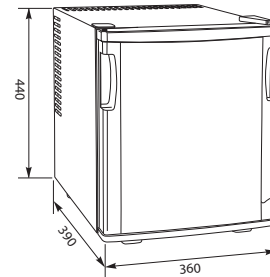

## TOP A+ 30 LT.

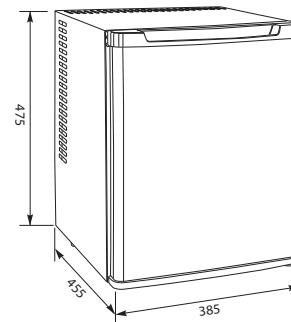

## TOP A+ 28 LT. \*

\*profondità / depth / profondeur  
385 mm

## TOP A+ 40 LT.

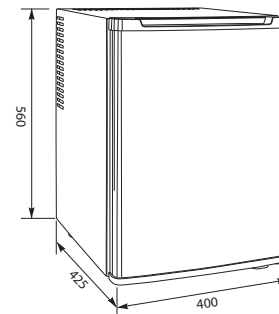

CARATTERISTICHE / FEATURES / CARACTÉRISTIQUES	Mod. TOP A+ 25 lt.	Mod. TOP A+ 28 lt.	Mod. TOP A+ 30 lt.	Mod. TOP A+ 40 lt.
Colore	Nero (PVC)	Nero (PVC)	Nero (PVC)	Nero (PVC)
Color	Black (PVC)	Black (PVC)	Black (PVC)	Black (PVC)
Coleur	Noir (PVC)	Noir (PVC)	Noir (PVC)	Noir (PVC)
Tipo installazione	<b>Incasso o libera installazione</b>			
Installation type	Built-in or free	Built-in or free	Built-in or free	Built-in or free
Installation	Encastrée ou libre	Encastrée ou libre	Encastrée ou libre	Encastrée ou libre
Classe energetica	<b>A+</b>			
Energy class	<b>A+</b>			
Classe énergétique	<b>A+</b>			
Volume refrigerato	19 lt.	26 lt.	32 lt.	35 lt.
Refrigerated compartment	19 lt.	26 lt.	32 lt.	35 lt.
Volume	<b>A+</b>			
Dimensioni esterne A x L x P	440x360x390 mm	475x385x385 mm	475x385x455 mm	560x400x425 mm
External dimensions H x W x D	440x360x390 mm	475x385x385 mm	475x385x455 mm	560x400x425 mm
Dimensions externe H x L x P	440x360x390 mm	475x385x385 mm	475x385x455 mm	560x400x425 mm
Peso netto	9,5 Kg	8,5 Kg	11 Kg	11,8 Kg
Net weight	9,5 Kg	8,5 Kg	11 Kg	11,8 Kg
Poids net	9,5 Kg	8,5 Kg	11 Kg	11,8 Kg
Potenza assorbita	63 W	63 W	60 W	63 W
Absorption System	63 W	63 W	60 W	63 W
Puissance absorbée	63 W	63 W	60 W	63 W
Consumo giornaliero	0,28 kWh/24	0,285 kWh/24	0,26 kWh/24	0,269 kWh/24
Daily consumption	0,28 kWh/24	0,285 kWh/24	0,26 kWh/24	0,269 kWh/24
Consommation journalière	0,28 kWh/24	0,285 kWh/24	0,26 kWh/24	0,269 kWh/24
Consumo annuo	104 kWh	104 kWh	96 kWh	98,19 kWh
Annual consumption	104 kWh	104 kWh	96 kWh	98,19 kWh
Consommation annuelle	104 kWh	104 kWh	96 kWh	98,19 kWh
n° ripiani interni regolabili	2	4	4	4
n° adjustable transparent shelves	2	4	4	4
n° étagères internes réglables	2	4	4	4



# COMUNITÀ

*Communities - Collectivité*







# PRO PHON - FIT PHON 1000W

ASCIUGACAPELLI - HAIR DRYERS - SÈCHE-CHEVEUX

## FIT PHON 1000W



-  **Pulsante a rilascio**  
Cavo spiralato 0,5 mt. + cavo lineare 1,5 mt.  
con spina bipolare Italia  
Risparmio energetico, max. 1000 W
-  **Push / release button**  
Cable length 0,5 mt. (coiled) + 1,5 mt.  
(linear), with plug  
Energy saving, max. 1000 W
-  **Bouton-poussoir**  
Cable 0,5 mt. (spirale) + 1,5 mt. (linéaire),  
avec prise bipolaire  
Épargné énergétique, max. 1000 W



### CARATTERISTICHE TECNICHE / TECHNICAL FEATURES / CARACTÉRISTIQUES TECHNIQUES

Funzionamento	Pulsante a rilascio	Potenza	max. 1000 W	Peso	
Functioning	Push / release button	Power	max. 1000 W	Weight	0,900 Kg
Activation	Bouton-poussoir	Puissance	max. 1000 W	Poids net	
Grado di protezione elettrica		Frequenza		Materiale	ABS bianco / nero
Electrical Protection Level	CLASS II	Frequency	50-60 Hz	Materials	ABS white / black
Isolation électrique		Fréquence		Matériel	ABS blanc / noir
Tensione		Volume aria		Dimensioni A x L x P	
Supply Voltage	220 V-240 V	Air Flow	max. 30,0 L/s	Dimensions H x W x D	287 x 275 x 95 (mm)
Tension d'alimentation		Débit d'air		Dimensions H x L x P	



## PRO PHON 1800W

-  **Pulsante on / off**  
Cavo spiralato 0,5 mt. + cavo lineare 1,00 mt.  
con spina bipolare Italia  
Potenza max. 1800 W
-  **On / off button**  
Cable length 0,5 mt. (coiled) + 1,00 mt. (linear),  
with plug  
Max. power 1800 W
-  **Bouton on / off**  
Cable 0,5 mt. (spirale) + 1,00 mt. (linéaire),  
avec prise bipolaire  
Puissance max. 1800 W



### CARATTERISTICHE TECNICHE / TECHNICAL FEATURES / CARACTÉRISTIQUES TECHNIQUES

Funzionamento	Tasto ON/OFF	Potenza	max. 1800 W	Peso	
Functioning	ON/OFF switch	Power	max. 1800 W	Weight	0,500 Kg
Activation	Bouton ON/OFF	Puissance	max. 1800 W	Poids net	
Grado di protezione elettrica		Frequenza		Materiale	
Electrical Protection Level	CLASS II	Frequency	50-60 Hz	Materials	ABS
Isolation électrique		Fréquence		Matériel	
Tensione		Volume aria		Dimensioni A x L x P	
Supply Voltage	220 V-240 V	Air Flow	max. 30,0 L/s	Dimensions H x W x D	205 x 225 x 91 (mm)
Tension d'alimentation		Débit d'air		Dimensions H x L x P	

-  **SUPPORTO PHON UNIVERSALE (OPZIONALE)**  
Base murale in ABS nero, con blocca cavo all'interno del supporto, ideale per uso comunitario.
-  **BLACK ABS WALL BASE (OPTION)** Cable Locking inside, recommended for heavy traffic.
-  **SUPPORT MURAL EN ABS (OPTIONNEL)**  
Support mural en ABS noir, avec fixation antivol du câble, pour usage intensif.



# Stream Dry Hair

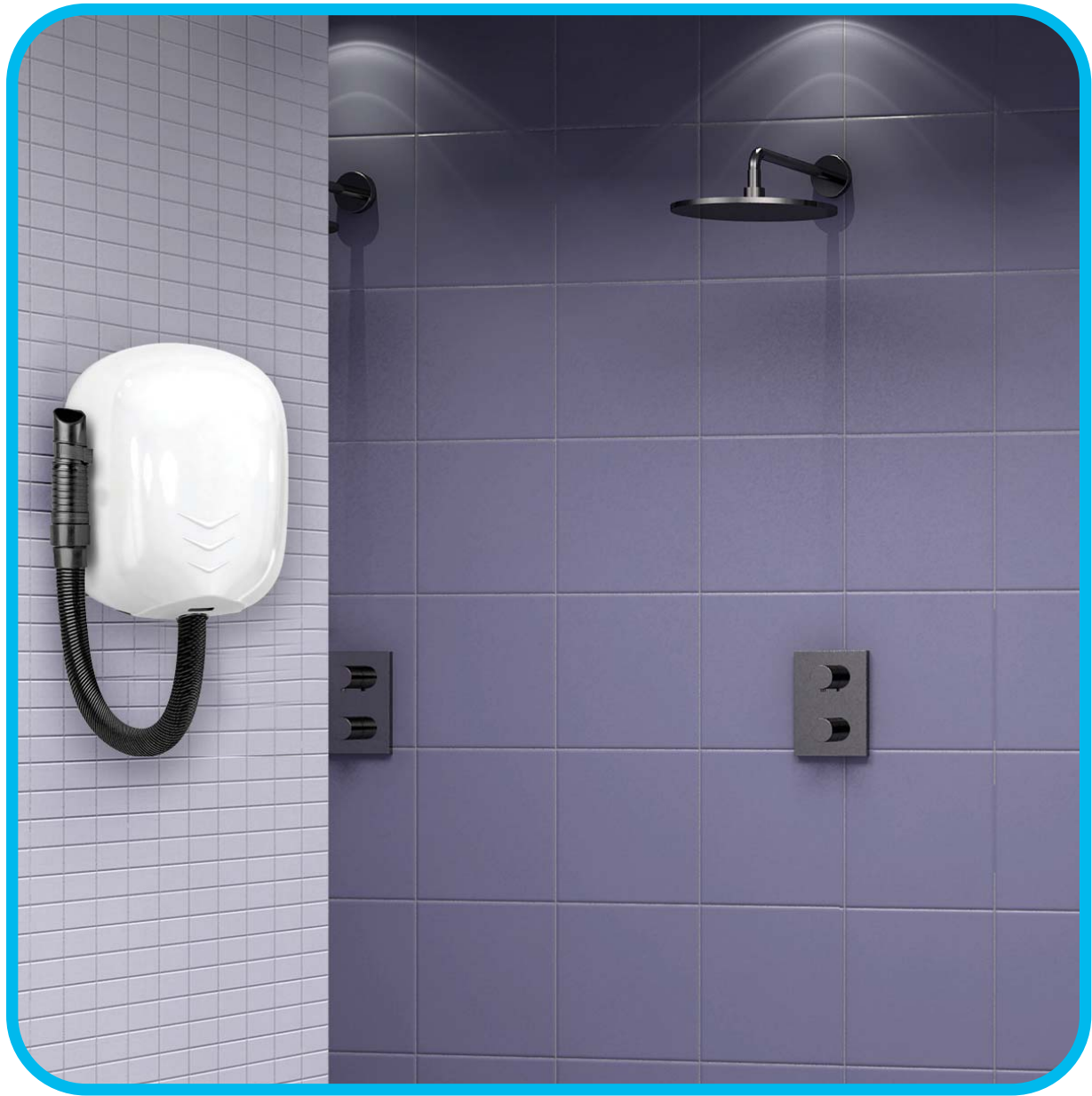

**VELOCITÀ ASCIUGATURA**  
*DRYING TIME / TEMPS DE SÉCHAGE*



**RISPARMIO ENERGETICO**  
*ENERGY SAVING / ÉPARGNE ENERGETIQUE*



**SILENZIOSITÀ**  
*NOISELESS / SILENCIEUX*



**DESIGN**



**ANTIVANDALISMO**  
*ANTIVANDALISM / ANTIVANDALISME*





# STREAM DRY HAIR

ASCIUGACAPELLI - HAIR DRYERS - SÈCHE-CHEVEUX

Stream  
Dry Hair



- 
**- Asciugacapelli ECO-JET in acciaio antivandalo** , con tubo estensibile antistrappo.
  - Grande risparmio energetico, assorbimento pari a soli 1100 W
  - Ampia gamma di modelli e finiture: versioni a smalto di colore bianco o nero-goffrato e in acciaio INOX AISI 304 lucido e satinato
  - Massima sicurezza: doppio termostato sia sulla resistenza che sul motore.
  
- 
**- ECO-JET hair dryer, vandal-proof steel cover**, with hose
  - 300 km/h air speed
  - Energy saving: max. power 1100 W
  - Wide range of models and finishings: white and black embossed painted, AISI 304 stainless steel satin and bright
  - Maximum safety: double thermostat on resistance / engine
  
- 
**- Sèche-cheveux ECO-JET en acier anti-vandalisme** , avec tube extensible anti-déchirure.
  - Vitesse de l'air de 300 Km/h
  - Grande économie d'énergie, absorption de seulement 1100 W.
  - Large gamme de modèles et de finitions: version en émail blanc ou gaufré noire et en acier inoxydable AISI 304 poli et satiné.
  - Sécurité maximale: double thermostat sur la résistance et le moteur.

**GARANZIA 2 ANNI • WARRANTY 2 YEARS • GARANTIE 2 ANS**



Cod.

<b>STREAM DRY HAIR ABS</b>	Polipropilene bianco / Polypropylene white / Polypropylène blanc
<b>STREAM DRY HAIR BF</b>	Acciaio verniciato bianco / Stainless steel white / Acier blanc
<b>STREAM DRY HAIR LF</b>	Acciaio inox AISI 304 lucido / Bright AISI 304 stainless steel / Acier inox Aisi 304 brillant
<b>STREAM DRY HAIR SF</b>	Acciaio inox AISI 304 satinato / Satin AISI 304 stainless steel / Acier AISI 304 satin
<b>STREAM DRY HAIR NF</b>	Acciaio con verniciatura goffrata nera / Black metallic paint, embossed finish / Acier avec peinture métallisée noire, finition en relief





Polipropilene bianco



INOX bianco (BF)



INOX satinato (SF)



INOX cromato (LF)

#### CARATTERISTICHE TECNICHE / TECHNICAL FEATURES / CARACTÉRISTIQUES TECHNIQUES

Giri al minuto	
Tr min	26.000 rpm
Revolutions per minute	
Grado di protezione elettrica	
Electrical Protection Level	CLASSE II - IP 23
Isolation électrique	
Tensione	
Supply Voltage	220 V-240 V
Tension d'alimentation	
Potenza totale	
Total power	1100 W
Puissance total	
Potenza resistenza	
Absorption Heating Element	550 W
Puissance chauffage	
Potenza motore	
Absorption Motor	550 W
Puissance moteur	
Dimensioni A x L x P	285 x 221 x 157 (tubo escluso)
Dimensions H x W x D	285 x 221 x 157 (without house)
Dimensions H x L x P	285 x 221 x 157 (sans tube)
Frequenza	
Frequency	50-60 Hz
Fréquence	
Velocità aria	
Air Speed	300 Km/h
Vitesse d'air	
Volume aria	
Air Flow	187 mc/h
Débit d'air	

Peso	
Weight	5 Kg
Poids net	
Materiale	Polipropilene - Acciaio INOX
Materials	Polypropylene - Steel
Matériel	Polypropylène - Acier
Marchi di qualità	
Quality marks - certifications	CE
Certification	
Rumorosità (2 mt)	
Noise Level (2 mt)	75 db
Niveau sonore (2 mt)	
Garanzia	2 anni*
Warranty	2 years*
Garantie	2 ans*

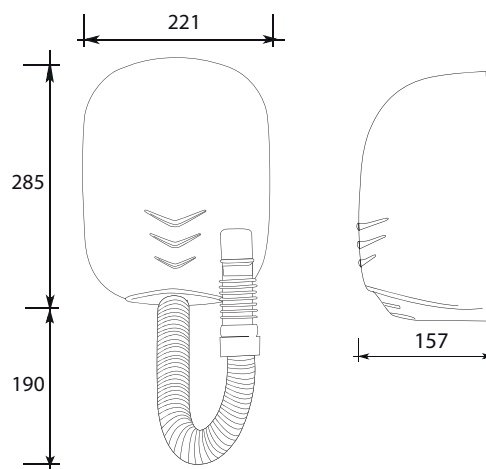

🇮🇹 \* Per le limitazioni di garanzia si vedano le condizioni generali di servizio

🇬🇧 \* Limited warranty. Please have a look to the General Warranty Conditions for details and consumables

🇫🇷 \* Limitations de garantie: en revoir Conditions de Garantie Generale

# ARIEL HAIR - ARIEL HAIR CON TUBO

ASCIUGACAPELLI / HAIR DRYERS / SÈCHE-CHEVEUX

ARIEL HAIR



VAMA



**ARIEL HAIR /BP  
(2400 W - 1700 W)**



**ARIEL HAIR CON TUBO / BP (1200 W)  
ARIEL HAIR WITH HOSE / BP (1200 W)  
ARIEL HAIR AVEC TUBE / BP (1200 W)**

-  Asciugacapelli in acciaio antivandalo, funzionante a pulsante, potenza 2400 W o 1700 W. Disponibile anche nella versione con tubo estensibile antistrappo (ARIEL HAIR CON TUBO), potenza 1200 W.  
Ampia gamma di modelli e finiture: versione a smalto di colore bianco, in acciaio INOX AISI 304 lucido e satinato.  
Timer regolabile tra 30 sec. - 3 min.  
Massima sicurezza: doppio termostato sia sulla resistenza che sul motore.
-  Hair dryer in vandal-proof steel, push- button operating, power 2400 W or 1700 W. Also available with hose (ARIEL HAIR WITH HOSE), power 1200 W.  
Wide range of models and finishings: white version or AISI 304 stainless steel satin and bright.  
Timer adjustable from 30 sec - 2 min. 30 sec.  
Maximum safety: double thermostat on resistance / engine.
-  Sèche-cheveux en acier anti-vandalisme, avec bouton poussoir, puissance 2400 W ou 1700 W.  
Disponible avec tube extensibles (ARIEL HAIR AVEC HOSE), puissance 1200 W.  
Large gamme de modèles et de finitions: version de couleur blanc, en acier inox AISI 304 satiné au brillant.  
Minuterie réglable de 30 sec - 2 min. 30 sec.  
Sécurité maximale: double thermostat sur la résistance et sur le moteur.

**GARANZIA 2 ANNI • WARRANTY 2 YEARS • GARANTIE 2 ANS**









## MODELLI & CODICI - PRODUCT CODES - CODES DE PRODUIT

	CODICI / CODES	COLORE COLOR COULEUR	POTENZA POWER PUISSANCE	FUNZIONAMENTO OPERATION FONCTIONNEMENT	TIMER
	ARIEL HAIR /BP	Bianco white / blanc	2400 W / 1700 W	Pulsante Push button Poussoir	30 sec. - 3 min.
	ARIEL HAIR /SP	Satinato Brushed / Satin	2400 W / 1700 W		
	ARIEL HAIR /LP	Lucido Bright / Brillant	2400 W / 1700 W		
	ARIEL HAIR CON TUBO (with hose / avec tube) /BP	Bianco white / blanc	1200 W		
	ARIEL HAIR CON TUBO (with hose / avec tube) /SP	Satinato Brushed / Satin	1200 W		
	ARIEL HAIR CON TUBO (with hose / avec tube) /LP	Lucido Bright / Brillant	1200 W		

# ARIEL HAIR - ARIEL HAIR CON TUBO

ASCIUGACAPELLI / HAIR DRYERS / SÈCHE-CHEVEUX



-  Saliscendi per ARIEL HAIR in acciaio INOX AISI 304 lucido.  
Dimensioni (A x L x P) 1000 X 300 X 150 mm; peso kg 23,50.
-  Height adjuster for ARIEL HAIR. AISI 304 bright stainless steel  
Dimensions (H x W x D) 1000 X 300 X 150 mm; weight kg 23,50.
-  Systeme de réglage en hauteur des appareils ARIEL HAIR, en acier inox AISI 304 brillant  
Dimensions (H x L x P) 1000 X 300 X 150 mm; poids net kg 23,50.
-  ABBINALO ALLA GETTONIERA GET/1 oppure GET/REG/SPECIAL - GET ARIEL SPECIAL (raccomandate)
-  Match it with GET/1 or GET/REG/SPECIAL - GET ARIEL SPECIAL (recommended)
-  Utilisation avec monnayeur GET/1 ou GET/REG/SPECIAL - GET ARIEL SPECIAL (recommandé)

## CARATTERISTICHE TECNICHE / TECHNICAL FEATURES / CARACTÉRISTIQUES TECHNIQUES

Giri al minuto	
Tr min	5500 rpm
Revolutions per minute	
Grado di protezione elettrica	
Electrical Protection Level	CLASS I - IP20
Isolation électrique	
Tensione	
Supply Voltage	220 V-240 V
Tension d'alimentation	
Potenza totale	2400 - 1700W (ARIEL HAIR)
Total power	1200W (ARIEL HAIR con tubo/with hose/avec tube)
Puissance total	
Potenza resistenza	2200 - 1500W (ARIEL HAIR)
Absorption Heating Element	1000W (ARIEL HAIR con tubo/with hose/avec tube)
Puissance chauffage	
Potenza motore	
Absorption Motor	200W
Puissance moteur	
Dimensioni A x L x P	
Dimensions H x W x D	243 x 278 x 213 (mm)
Dimensions H x L x P	
Frequenza	
Frequency	50-60 Hz
Fréquence	
Velocità aria	
Air Speed	101 Km/h , 30 m/s
Vitesse d'air	
Volume aria	
Air Flow	90 L/s , 330 cbm/h
Débit d'air	

Peso	
Weight	4,8 Kg - 5,5 Kg con tubo
Poids net	
Materiale	Acciaio
Materials	Steel
Matériel	Acier
Marchi di qualità	
Quality marks - certifications	CE
Certification	
Rumorosità (2 mt)	
Noise Level (2 mt)	70 dB
Niveau sonore (2 mt)	
Garanzia	2 anni*
Warranty	2 years*
Garantie	2 ans*

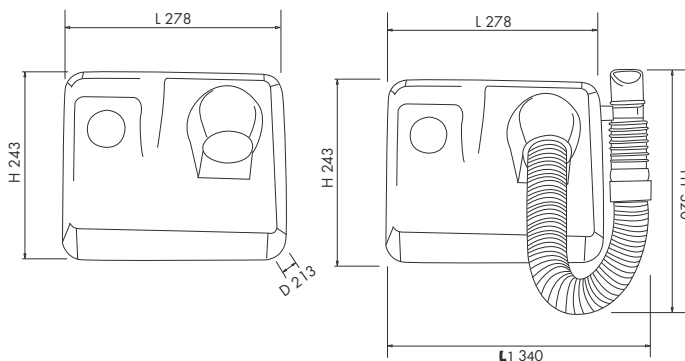

Dimensioni tubo interno  $\varnothing$  38 mm  
Dimensioni tubo esterno  $\varnothing$  46 mm  
Dimensioni tubo estensibile 1 mt

 \* Per le limitazioni di garanzia si vedano le condizioni generali di servizio

 \* Limited warranty. Please have a look to the General Warranty Conditions for details and consumables

 \* Limitations de garantie: en voir Conditions de Garantie Generale



# UNIK HAIR - ACEA

ASCIUGACAPELLI / HAIR DRYERS / SÈCHE-CHEVEUX



UNIK HAIR



ACEA

## **ASCIUGACAPELLI PROFESSIONALI IN ABS**

- Ottimo rapporto tra performance / consumi / budget di spesa
- Massima silenziosità: inferiore a 60 db
- Motore a induzione
- Grande varietà di gamma: versioni a 1200 W e 1600 W (solo ACEA SUPER), con funzionamento a pulsante o a mezzo di dispositivo per la gestione dei servizi a pagamento (gettoniera)
- Temporizzazione fissa 3 min. (ACEA), regolabile tra 30 sec. - 3 min (UNIK HAIR)
- Termostato di sicurezza

## **PROFESSIONAL ABS HAIR DRYERS**

- The best balance between performance / electricity consumption / budget
- Noiseless: less than 60 db
- Brushless motors
- Wide range: 1200 W version or 1600 W (ACEA SUPER ONLY). Push button or coin unit operating
- Timer 3 min., (ACEA); adjustable timer 30 sec. - 3 min. (UNIK HAIR)
- Overheating protection.

## **SÈCHE-CHEVEUX PROFESSIONNEL**

- Excellentes relations entre la performance / consommations / budget des dépense.
- Niveau sonore: moins de 60 db.
- Moteur à induction.
- Grande variété des versions: 1200 W et 1600 W (SUPER ACEA), avec bouton poussoir ou capteur ou system de paiement.
- Minuterie 3 min (ACEA), réglable de 30 sec. - 3 min (UNIK HAIR).
- Thermostat de sécurité.





**GARANZIA 2 ANNI • WARRANTY 2 YEARS • GARANTIE 2 ANS**

 \* Per le limitazioni di garanzia si vedano le condizioni generali di servizio



 \* Limited warranty. Please have a look to the General Warranty Conditions for details and consumables



 \* Limitations de garantie: en revoir Conditions de Garantie Generale



-  Saliscendi per ACEA in acciaio INOX AISI 304 lucido.  
Dimensioni (A x L x P) 1040 X 340 X 120 mm; peso 6 kg
-  Height adjuster for ACEA. AISI 304 bright stainless steel  
Dimensions (H x W x D) 1040 X 340 X 120 mm; weight 6 kg
-  Systeme de réglage en hauteur des appareils ACEA en acier inox AISI 304 brillant  
Dimensions (H x L x P) 1040 X 340 X 120 mm; poids net 6 kg



-  ABBINALO ALLA GETTONIERA GET/1 – GET/REG/SPECIAL – GET/MULTI
-  Match it with GET/1 – GET/REG/SPECIAL – GET/MULTI
-  Utilisation avec monnayeur GET/1 – GET/REG/SPECIAL – GET/MULTI

	CODICI / CODES	COLORE COLOR COULEUR	POTENZA POWER PUISSANCE	FUNZIONAMENTO OPERATION FONCTIONNEMENT	TIMER
	UNIK HAIR /BP	Bianco white blanc	1200 W	Pulsante/Push button/Poussoir	30 sec. - 3 min.
	UNIK HAIR /BF			Automatico/Sensor/Capteur	//
	UNIK/HAIR/GET/BP			Gettoniera/Coin Unit Système de monnayeur GET/1	30 sec. - 3 min.
	UNIK/HAIR/ SPECIAL/BP			Gettoniera/Coin Unit Système de monnayeur GET REG SPECIAL	30 sec. - 6 min.
	ACEA/87	Bianco white blanc	1200 W	Pulsante/Push button/Poussoir	3 min.
	ACEA/SUPER/87		1600 W	Pulsante/Push button/Poussoir	3 min.
	ACEA/E/SUPER/87			Automatico/Sensor/Capteur	//
	ACEA/GET		1200 W 1600 W	Gettoniera/Coin Unit Système de monnayeur GET/1	3 min.
	ACEA/SPECIAL			Gettoniera/Coin Unit Système de monnayeur GET REG SPECIAL	30 sec. - 6 min.
	ACEA/MULTI			Gettoniera/Coin Unit Système de monnayeur GET/MULTI	30 sec. - 5 min.

### CARATTERISTICHE TECNICHE

### TECHNICAL FEATURES / CARACTÉRISTIQUES TECHNIQUES

Tensione	
Supply Voltage	220 V-240 V
Tension d'alimentation	
Frequenza	
Frequency	50-60 Hz
Fréquence	
Volume aria	
Air Flow	45 L/s , 160 cbm/h
Débit d'air	
Peso	
Weight	3 kg
Poids net	
Materiale	
Materials	ABS
Matériel	
Marchi di qualità	
Quality marks - certifications	CE
Certification	
Rumorosità (2 mt)	
Noise Level (2 mt)	60 db
Niveau sonore (2 mt)	

UNIK HAIR

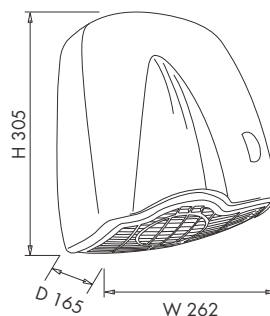

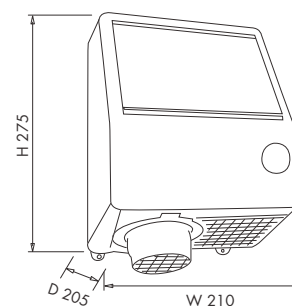

ACEA



# TURBO3

## ASCIUGACAPELLI / HAIR DRYERS / SÈCHE-CHEVEUX

-  - Asciugacapelli in ABS con tubo flessibile
- Potenza 700 W
- Attivazione automatica quando si sgancia il tubo (standard)  
Abbinabile a dispositivo per la gestione dei servizi a pagamento (gettoniera)
- Autospegnimento dopo 5 min. in caso di mancato riaggancio del tubo
- Termostato di sicurezza

-  - Wall mounted ABS hair dryer with flexible hose
- Potenza 700 W
- Auto turn-on when hose is released (standard version)  
Available coin unit operating model
- Auto turn off after 5 min
- Overheating protection

-  - Sèche-cheveux mural en ABS avec tube extensible
- Puissance 700 W
- Automatique (standard) / Avec Systeme de temporisateur
- Arrêt automatique (auto-timer): au bout de 5 minutes en cas de non repositionnement du tube
- Thermostat de sécurité



### GARANZIA 2 ANNI • WARRANTY 2 YEARS • GARANTIE 2 ANS

 \* Per le limitazioni di garanzia si vedano le condizioni generali di servizio

 \* Limited warranty. Please have a look to the General Warranty Conditions for details and consumables

 \* Limitations de garantie: en revoir Conditions de Garantie Generale



 ABBINALO ALLA GETTONIERA GET/REG/SPECIAL

 Match it with GET/REG/SPECIAL

 Utilisation avec monnaieur GET/REG/SPECIAL



### CARATTERISTICHE TECNICHE / TECHNICAL FEATURES / CARACTÉRISTIQUES TECHNIQUES

Funzionamento	Allo sganciamento del tubo
Functioning	Auto turn-on when hose is released
Activation	Automatique a la poigné
Grado di protezione elettrica	
Electrical Protection Level	CLASS II
Isolation électrique	
Tensione	
Supply Voltage	220 V-240 V
Tension d'alimentation	
Potenza	
Power	700 W
Puissance	
Frequenza	
Frequency	50-60 Hz
Fréquence	
Volume aria	
Air Flow	45 L/s , 160 cbm/h
Débit d'air	
Peso	
Weight	2,7 kg
Poids net	

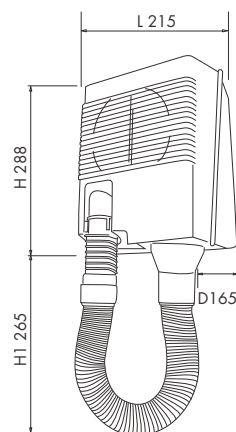
Materiale	
Materials	ABS
Matériel	





Dimensioni tubo interno  $\varnothing$  38 mm  
Dimensioni tubo esterno  $\varnothing$  46 mm  
Dimensioni tubo estensibile 1 mt

	CODICI / CODES	COLORE COLOR COULEUR	POTENZA POWER PUISSANCE	FUNZIONAMENTO OPERATION FONCTIONNEMENT	TIMER
	TURBO/3	Bianco white / blanc	700 W	Alla estrazione del tubo When hose is pull out Engageant la poignée	5 min.
	TURBO/SPECIAL			Gettoniera / Coin Unit Système de monnaieur GET REG SPECIAL	30 sec. - 6 min.



# GETTONIERE - COIN SYSTEMS - MONNAYEURS

COMUNITÀ / COMMUNITIES / COLLECTIVITÉ

-  Gamma completa di dispositivi per la fornitura di servizi a pagamento.  
Enorme varietà di applicazioni, dalla temporizzazione di numerose tipologie di apparecchi (asciugacapelli, docce, lavatrici e asciugatrici, idromassaggi, illuminazione campi sportivi ecc.) al controllo e gestione dei flussi di traffico di veicoli e persone (sbarre di accesso a parcheggi e a zone a traffico limitato; apertura di serrature, apertura tornelli di accesso ecc.)  
Evitano l'abuso e gli sprechi nell'utilizzo di apparecchiature, consentendo la razionalizzazione dei servizi e la realizzazione di ulteriori introiti
-  Wide range of devices for supplying of services subject to charges.  
Huge variety of applications: timing of many types of appliances (hair dryers, showers, washing machines, Jacuzzi, sports lighting, etc.); controlling and managing vehicles / people traffic (parking areas bars; opening of locks, turnstiles etc.)  
Preventing abuse and waste in the use of equipment, allowing the rationalization of services and the creation of additional revenue
-  Gamme complète de dispositifs pour fournir des services payants.  
Grande variété d'applications: pour la synchronisation de nombreux types d'appareils (sèche-cheveux, douches, machines à laver et sèche, bain à remous, d'éclairage des terrains de sport, etc.), pour contrôler et gérer la circulation des véhicules et des personnes (les bars et les accès aux aires de stationnement, l'ouverture des écluses, tourniquets d'accès, etc.)  
Prévenir l'abus et le gaspillage dans l'utilisation des équipements, permettant la rationalisation des services et la création de revenus supplémentaires



GETTONIERE

VAMA

## GETTONIERE SINGOLE / SINGLE COIN UNIT / SYSTEME DE PAIEMENT

GARANZIA 2 ANNI - 2 YEARS WARRANTY - 2 ANS GARANTIE



-  FUNZIONAMENTO: moneta (10 o 20 o 50 centesimi o 1 o 2 Euro)  
o a gettone (una unica scelta possibile)
-  OPERATION: money (10 or 20 or 50 cents, or 1 or 2 euro) or token (only one choice)
-  FONCTIONNEMENT: monnaie (10, 20 ou 50 cents, ou 1 ou 2 euros)  
ou jeton (un seul choix)

GET/1



UTILIZZALA CON  
USE IT WITH  
UTILISEZ AVEC





UNIK HAIR

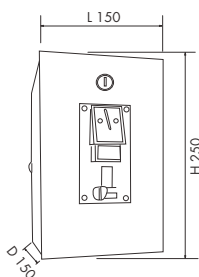

ACEA GET







-  La gettoniera prevede esclusivamente un contatto pulito di 150 millisecondi al passaggio della moneta / gettone.
-  The coin unit provides only a clean contact of 150 milliseconds to passage of coin / token.
-  Le système de paiement fournit uniquement un contact propre de 150 millisecondes au passage de la pièce / jeton.

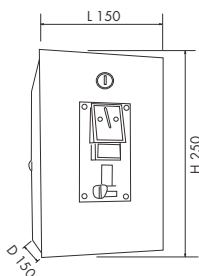

Peso: 3,0 kg. - Weight: 3,0 kg. - Poids: 3,0 kg.

GET/REG



-  Gettoniera idonea per collegamento con qualsiasi tipo di apparecchiatura da temporizzare.  
Timer regolabile da 1 secondo a 300 ore.
-  Coin unit suitable for timing of wide range of equipment.  
Adjustable timer from 1 second to 300 hours.
-  Le système de paiement approprié pour la connexion de nombreux types d'appareils.  
Temporisateur réglable de 1 seconde à 300 heures.



Peso: 3,20 kg. - Weight: 3,20 kg. - Poids: 3,20 kg.

# GETTONIERE - COIN SYSTEMS - MONNAYEURS

COMUNITÀ / COMMUNITIES / COLLECTIVITÉ

## GET/REG/SPECIAL



UTILIZZALA CON  
USE IT WITH  
UTILISEZ AVEC

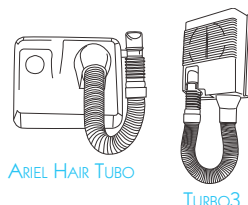

ARIEL HAIR TUBO

TURBO3

## GET/ARIEL/SPECIAL



UTILIZZALA CON  
USE IT WITH  
UTILISEZ AVEC



ARIEL HAIR

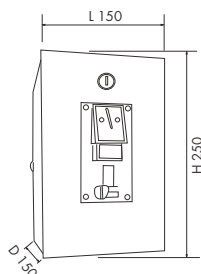

- 🇮🇹 Gettoniere per asciugacapelli con timer regolabile fino a 6 min.
- 🇬🇧 *Coin unit suitable for hair dryers timing. Adjustable timer up to 6 min.*
- 🇫🇷 Le système de paiement approprié pour le sèche-cheveux. Avec temporisateur réglable jusqu'à 6 min.



Peso: 3,20 kg. - Weight: 3,20 kg. - Poids: 3,20 kg.

## GET/DOCCIA

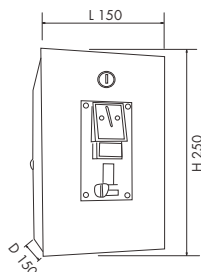

- 🇮🇹 Gettoniera per doccia con timer regolabile da 1 secondo a 300 ore  
Elettrovalvola da 1/2 pollice e alimentatore 12 V inclusi
- 🇬🇧 *Coin unit suitable for showers of wide range of equipment, timer 1 sec - 300 h*
- 🇫🇷 Le système de paiement approprié pour douche, avec alimentateur 12 Vac et électrovalve  
Temporisateur réglable de 1 seconde à 300 heures



Peso: 3,80 kg. - Weight: 3,80 kg. - Poids: 3,80 kg.

## GET/ILL

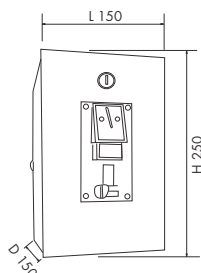

- 🇮🇹 Gettoniera adatta all'illuminazione di campi sportivi, con doppio timer regolabile fino a 12 ore, funzionante solo a gettone. Predisposta per segnale acustico o luminoso prima della scadenza del tempo
- 🇬🇧 *Coin unit with double timer adjustable up to 12 h, suitable for using in public lighting as football, tennis, or any else. It's possible to connect an acoustic or lighting advice before time finishing*
- 🇫🇷 Le système de paiement approprié pour l'éclairage de les terrains de sport, avec double temporisateur réglable jusqu'à 12 h. Possibilité de connexion au signal acoustique ou lumineux avant la fin du temps



Peso: 3,50 kg. - Weight: 3,50 kg. - Poids: 3,50 kg.

### CARATTERISTICHE GENERALI

### GENERAL FEATURES

### CARACTÉRISTIQUES GÉNÉRALES

Materiale centralina	Lamiera d'acciaio zincato bianco
Box material	Steel, zinc plated, white colour
Matériel de la boîte	Acier, plaqué zinc, blanc
Chiusura coperchio	Con serratura a chiave
Closing	Lockable
Fermeture	Avec clé
Frequenza	
Frequency	50-60 Hz
Fréquence	
Grado di protezione elettrica	
Electrical Protection Level	CLASS I
Isolation électrique	

### GET/REG

### GET/REG/SPECIAL GET/ARIEL/SPECIAL

Tensione di alimentazione	
Supply Voltage	220 V-240 V
Tension d'alimentation	
Uscita	
Exiting	220 V-240 V
Sortie	
Portata massima	
Max capacity	1000 W
Débit maximum	

### GET/1

Tensione di alimentazione	Non prevista
Supply Voltage	...
Tension d'alimentation	...
Uscita	Contatto pulito su faston maschio
Exiting	Clean contact
Sortie	Contact propre
Portata massima	Non prevista
Max capacity	...
Débit maximum	...

### GET/DOCCIA

### GET/ILL

Tensione di alimentazione	
Supply Voltage	12 V
Tension d'alimentation	
Uscita	
Exiting	12 V
Sortie	
Portata massima	
Max capacity	100 W
Débit maximum	

# GETTONIERE - COIN SYSTEMS - MONNAYEURS

COMUNITÀ / COMMUNITIES / COLLECTIVITÉ

## GET/VETRORESINA

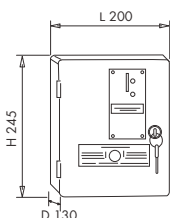

- Casseta idonea all'utilizzo in ambienti esterni (classe I). Modalità di funzionamento possibile come modelli GET/1; GET/REG; GET/REG/SPECIAL - GET/ARIEL/SPECIAL; GET/DOCCIA
- Coin unit suitable for outdoor use (class I). Operation as following models: GET/1; GET/REG; GET/REG/SPECIAL - GET/ARIEL/SPECIAL; GET/DOCCIA
- Le système de paiement adapté pour une utilisation en extérieur (class I). Mode de fonctionnement: GET/1; GET/REG; GET/REG/SPECIAL - GET/ARIEL/SPECIAL; GET/DOCCIA

Materiale centralina	Vetroresina, colore bianco
Box material	Fiberglass, white colour
Matériel de la boîte	Fibre de verre, blanc
Chiusura coperchio	Con serratura a chiave
Closing	Lockable
Fermeture	Avec clé

## GETTONIERE MULTIPLE/MULTI COIN UNIT/SYSTEMES DE PAIEMENT MULTIPLES

GARANZIA 2 ANNI - 2 YEARS WARRANTY - 2 ANS GARANTIE



- FUNZIONAMENTO: moneta (10 o 20 o 50 centesimi o 1 o 2 Euro) / gettone / scheda (una unica scelta possibile)
- OPERATION: money (10 or 20 or 50 cents, or 1 or 2 euro) /token / consumable card (only one choice)
- FONCTIONNEMENT: monnaie (10, 20 ou 50 cents, ou 1 ou 2 euros) / jeton / fiche de consommation (un seul choix)

## GETT/MULTI GETT/MULTI/SCHEDA



UTILIZZALA CON  
USE IT WITH  
UTILISEZ AVEC



ACEA MULTI

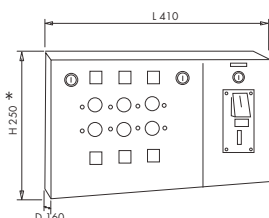

- Gettoniera per temporizzazione di asciugacapelli ACEA/MULTI, da 1 a 6 utenze, con timer regolabile 30 sec. - 5 min. Funzionante a moneta o gettone (GET/MULTI) oppure a scheda a consumo (GET/MULTI/SCHEDA) transponder a radio frequenza
- ACEA/MULTI coin unit, up to 6 contemporary uses, with adjustable timer, 30 sec. - 5 min.
- Systeme pour sèche-cheveux ACEA/MULTI, temporisateur réglable de 30 sec. à 5 min. (6 usages)

\* Altezza/Height/Hauteur mod."scheda": 300 mm

## GETT/DOCCIA/MULTI GETT/DOCCIA/MULTI/SCHEDA

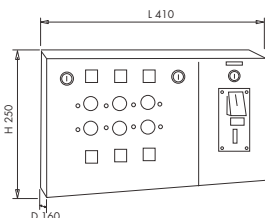



- Gettoniera per temporizzazione da 1 a 6 docce con timer regolabile da 30 sec. - 5 min. Funzionante a moneta o gettone (GET/DOCCIA/MULTI) oppure a scheda a consumo o sistema transponder a radio frequenza (GET/DOCCIA/MULTI/SCHEDA). Uscite 12 V
- Multi use coin unit, with adjustable timer 30 sec. - 5 min.
- Systeme multiple de temporizateurs pour douches (6 douches), fonctionnement avec credit rechargeable. Temporisateur réglable de 30 sec. à 5 min.

Materiale centralina	Lamiera d'acciaio zincato bianco	Frequenza	
Box material	Steel, zinc plated, white colour	Frequency	50-60 Hz
Matériel de la boîte	Acier, plaqué zinc, blanc	Fréquence	
Chiusura coperchio	Con serratura a chiave	Grado di protezione elettrica	
Closing	Lockable	Electrical Protection Level	CLASS I
Fermeture	Avec clé	Isolation électrique	

GETT/MULTI	Tensione di alimentazione	GETT/DOCCIA/MULTI	Tensione di alimentazione
	Supply Voltage		Supply Voltage
	230 V		230 V
GETT/MULTI/SCHEDA	Tension d'alimentation	GETT/DOCCIA/MULTI/SCHEDA	Tension d'alimentation
	Uscita		Uscita
	Exiting		Exiting
	12 V		12 V
	Sortie		Sortie



## COLONNA DOCCIA - SHOWER COLUMN - COLONNE DE DOUCHE

-  Colonna doccia in acciaio inox satinato AISI 304, con soffione doccia antivandalo e antifurto, con miscelatore caldo / freddo e pulsante temporizzato a pressione regolabile tra 20 e 30 secondi, completo di valvole di non ritorno. Ideale per centri sportivi e wellness, abbinabile anche a gettoniera GET DOCCIA.
-  Shower column in stainless steel AISI 304, with anti-vandalism and anti-theft showerhead, mixer with hot / cold and spring-timed button, adjustable between 20 and 30 seconds, complete with anti back flush valves on cold and warm water entries. Ideal for sports and wellness centers, the system can also be combined to coin unit GET DOCCIA.
-  Colonne de douche en acier inox AISI 304, avec erogateur antivandalisme et antiviol, table de mixage chaud / froid, activation avec bouton pression et chronométré réglable entre 20 et 30 secondes, avec clapets anti-retour eau chaude et froide. Idéal pour les sports et bien-être, le système peut également être combinées pour pièce monnayeur GET DOCCIA.





### CARATTERISTICHE TECNICHE / TECHNICAL FEATURES / CARACTÉRISTIQUES TECHNIQUES

Dimensioni A x L x P	Miscelatore regolabile
Dimensions H x W x D 1018 x 205 x 150 (mm)	Adjustable mixer
Dimensions H x L x P	Mélangeur réglable
Materiale Acciaio inox AISI 304 satinato	Pulsante temporizzato
Material AISI 304 satin stainless steel	Timing push-button
Matériel Acier inox AISI 304 satin	Bouton a pression temporisé
Soffione antivandalo e anti-impiccagione	Garanzia 2 anni
Antivandal blowpipe	2 years warranty
Antivandalisme	2 ans garantie

## ASPIRATORI - EXHAUST FANS - ASPIRATEURS



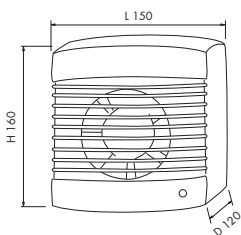

### ASM 100

-  Aspiratore da muro 12 W, portata 90 Mc/Ora
  -  Exhaust fan 12 W, 90 cbm/h
  -  Aspirateur murale 12 W, 90 Mc/h
- Dimensioni/Dimensions/Dimensions: 160 x 150 x 120 cm*  
*Peso/Weight/Poids 0,8 kg*



### ASM 120

-  Aspiratore da muro 20W, portata 165 Mc/Ora
  -  Exhaust fan 20 W, 165 cbm/h
  -  Aspirateur murale 20W, 165 Mc/h
- Dimensioni/Dimensions/Dimensions: 190 x 170 x 120 cm*  
*Peso/Weight/Poids 1 kg*



GARANZIA 2 ANNI - 2 YEARS WARRANTY - 2 ANS GARANTIE

# RUBINETTERIA - FAUCETS - ROBINETS

## 🇮🇹 RUBINETTO ELETTRONICO IN ACCIAIO INOX CON MIXER INTEGRATO

## 🇬🇧 STAINLESS STEEL AUTOMATIC FAUCET WITH MIXER

## 🇫🇷 ROBINET ÉLECTRONIQUE AVEC MIXEUR

- 🇮🇹 Rubinetto elettronico a fotocellula completamente in acciaio inox, per acqua fredda e calda, temperatura regolabile da mixer
  - Funzione di arresto automatico dopo 5 minuti di flusso continuo
  - Attivazione con sensore a infrarossi (range max di 0,3 m)
  - L'acqua smette di scorrere dopo la rimozione delle mani dal sensore con un ritardo di tempo regolabile
  - Tempo di ritardo regolabile da 0,25 a 7,75 sec.
  - Possibilità di regolazione ritardo, range attivo e commutazione

- 🇬🇧 Destined for cold and hot water, temperature is regulated by mixer
  - Function of automatic water stop after 5 minut of continuous flow
  - Water is flowing as long as hands are in the active range (max. range to 0,3 m)
  - Water stops flowing after removal of hands from the active range of sensor after adjustable time delay
  - Time delay from 0,25 to 7,75 sec.
  - Possibility of changing of time delay, active range and switching off

- 🇫🇷 Robinet capteur électronique infrarouge en acier inoxydable, eau chaude et froide, la température réglable avec mixeur
  - Fonction d'arrêt automatique après 5 minutes de débit continue
  - Activation avec capteur infrarouge (Portée Max de 0,3 m)
  - L'eau cesse de s'écouler après l'enlèvement des mains du capteur avec une temporisation réglable
  - Temporisation réglable de 0,25 à 7,75 sec.
  - Possibilité réglage temporization et distance detection



### CARATTERISTICHE TECNICHE TECHNICAL FEATURES / CARACTÉRISTIQUES TECHNIQUES

Funzionante con trasformatore 230V- 6V
Power input
Fonctionnement avec transformateur 230V- 6V
Tensione di sicurezza 6 Vdc
operating voltage 6V 1,4 W
Tension de fonctionnement 6V 1,4 W
Range di attivazione da 0 a 30 cm
Active range standard 0 - 0,3 m adjustable
Gamme Active Standard 0 à 0,3 m
Pressione raccomandata 0,1 – 0,6 Mpa
Recommended flow pressure 0,1 - 0,6 MPa
Pression d'écoulement recommandée de 0,1 à 0,6 MPa
Volume acqua erogata: 6L min.
Rate of flow 6 l/min. (inf. data)
Débit de 6 l / min.
2 Flessibili 3/8" inclusi
Water inlet male threads 3/8" included
2 flexibles eau chaude et froid inclus

**GARANZIA 2 ANNI • WARRANTY 2 YEARS • GARANTIE 2 ANS**



## 🇮🇹 RUBINETTO TEMPORIZZATO

## 🇬🇧 PUSH BUTTON WASHBASIN TAP

## 🇫🇷 ROBINET À PRESSION

- 🇮🇹 Rubinetto temporizzato per lavabo.  
Tempo di apertura standard: 8/12 secondi
- 🇬🇧 Push button washbasin tap.  
Standard opening time: 8/12 seconds
- 🇫🇷 Robinet Bouton pression pour bassin.  
Temps d'ouverture standard: 8/12 secondes

### CARATTERISTICHE TECNICHE TECHNICAL FEATURES / CARACTÉRISTIQUES TECHNIQUES

Materiale	Ottone cromato
Material	Chromed brass
Materiel	Laiton cromé







**LINEA IGIENE**

*Washroom Equipments - Équipements Sanitaires*



LINEA INOX

DISTRIBUTORI DI CARTA IGIENICA  
TOILET PAPER DISPENSERS / DISTRIBUTEURS A PAPIER TOILET

GARANZIA 2 ANNI - 2 YEARS WARRANTY - 2 ANS GARANTIE

200 MT.

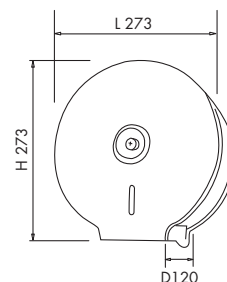

Peso / Weight / Poids: Kg. 2,0  
Ø anima 40 mm  
Rotolo / Roll / Rouleau max. Ø 270 mm

**ROLL INOX 200 MT.**

**ROLL INOX SATINATO 200 MT.**

Portarotoli inox lucido con serratura  
*Paper dispenser, bright stainless steel*  
Distributeur a papier toilet inox brillant

400 MT.

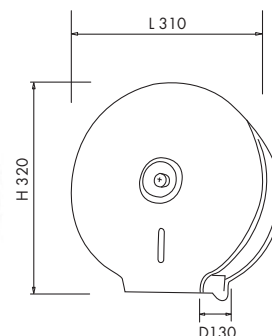

Peso / Weight / Poids: Kg. 2,2  
Ø anima 45 mm  
Rotolo / Roll / Rouleau max. Ø 300 mm

**ROLL INOX 400 MT.**

**ROLL INOX SATINATO 400 MT.**

Portarotoli inox satinato con serratura  
*Paper dispenser, satin stainless steel*  
Distributeur a papier toilet inox satin

DISTRIBUTORI DI CARTA ASCIUGAMANI  
HAND PAPER DISPENSERS / DISTRIBUTEURS A PAPIER

GARANZIA 2 ANNI - 2 YEARS WARRANTY - 2 ANS GARANTIE

**MAXI INOX 400 FOGLI/ SHEETS/ FEUILLES**

Distributore inox lucido con serratura, fazzoletti piegati a C  
*Interfolded hand paper dispenser, bright stainless steel*  
Distributeur a papier inox brillant

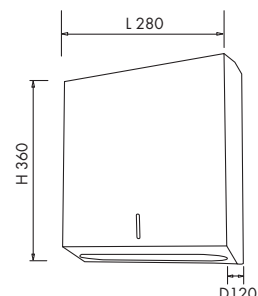

Peso / Weight / Poids: Kg. 2,3  
Capienza fino a 400 fogli di carta piegata a "C" o "Z"  
*Capacity up to 400 sheets, suitable for a "C" or "Z"*  
400 feuilles max. "C" ou "Z"

**MAXI INOX SATINATO 400 FOGLI/ SHEETS/ FEUILLES**

Distributore inox satinato con serratura, fazzoletti piegati a C  
*Interfolded hand paper dispenser, satin stainless steel*  
Distributeur a papier inox satin

**MAXI INOX 500 FOGLI/ SHEETS/ FEUILLES**

Distributore inox AISI 304 lucido con serratura, fazzoletti piegati a C  
*Interfolded hand paper dispenser, bright stainless steel AISI 304*  
Distributeur a papier inox AISI 304 brillant

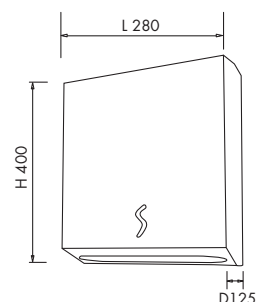

Peso / Weight / Poids: Kg. 2,5  
Capienza fino a 500 fogli di carta piegata a "C", "Z" o "V"  
*Capacity up to 500 sheets, suitable for a "C", "Z" or "V"*  
500 feuilles max. "C", "Z" ou "V"

LINEA INOX

DISTRIBUTORI DI SAPONE  
SOAP DISPENSERS / DISTRIBUTEURS A SAVON

GARANZIA 2 ANNI - 2 YEARS WARRANTY - 2 ANS GARANTIE



**DISA/Q - DISA/Q SATIN 1,2 lt.**

Distributore di sapone con serratura in acciaio inox AISI 304 lucido o satinato

*Soap dispenser, bright or satin stainless steel AISI 304*

Distributeur a savon inox AISI 304 brillant ou satin

**SISTEMA PUSH - PUSH SYSTEM**

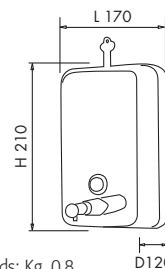

Peso / Weight / Poids: Kg. 0,8

Per tutti i tipi di sapone salvo a microgranuli  
*Accepts all kinds of soap except the Microgranules*



**DISA/L NEW 0,5 lt.**

Distributore di sapone in acciaio inox AISI 304 lucido

*Soap dispenser, bright stainless steel AISI 304*

Distributeur a savon inox AISI 304 brillant

**SISTEMA PUSH - PUSH SYSTEM**

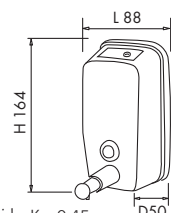

Peso / Weight / Poids: Kg. 0,45

Per tutti i tipi di sapone salvo a microgranuli  
*Accepts all kinds of soap except the Microgranules*



**DISA/PULL - DISA/PULL SATIN 1,2 lt.**

Distributore di sapone con serratura in acciaio inox lucido o satinato

*Soap dispenser, bright or satin stainless steel*

Distributeur a savon inox brillant ou satin

**SISTEMA PULL - PULL SYSTEM**

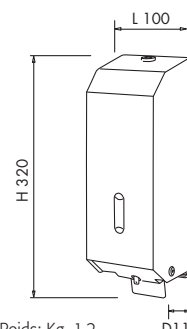

Peso / Weight / Poids: Kg. 1,2

Per tutti i tipi di sapone salvo a microgranuli  
*Accepts all kinds of soap except the Microgranules*

DISTRIBUTORE DI CARTA IGIENICA INTERFOGLIATA  
INTERFOLD TOILET TISSUE DISPENSER / DISTRIBUTEUR A FEUILLES PAPIER TOILET

GARANZIA 2 ANNI - 2 YEARS WARRANTY - 2 ANS GARANTIE



**C-FOLD**

Portacarta igienica interfogliata a C, inox lucido, fino a 2 pacchetti o due rotoli

*Interfolded toilet paper dispenser, bright stainless steel*

Distributeur a feuilles papier toilet inox brillant

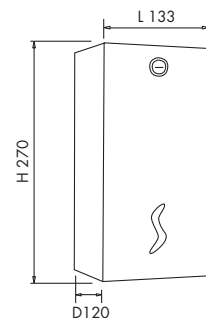

Peso / Weight / Poids: Kg. 2,0

DISTRIBUTORE DI SACCHETTI IGIENICI  
SANITARY TOWEL BAGS DISPENSER / DISTRIBUTEUR DE SACS SANITAIRES

GARANZIA 2 ANNI - 2 YEARS WARRANTY - 2 ANS GARANTIE



**DISIGIENICO - DISIGIENICO SATIN**

Distributore di sacchetti igienici, in acciaio inox AISI 304 lucido o satinato

*Sanitary towel bags dispensers, bright or satin stainless steel AISI 304*

Distributeur de sacs sanitaires, inox AISI 304 brillant ou satin

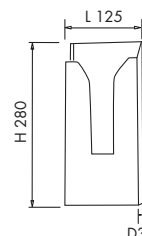

Peso / Weight / Poids: Kg. 0,6



## LINEA IGIENE / WASHROOM EQUIPMENTS / ÉQUIPEMENTS SANITAIRES

## MANIGLIONI MURALI / GRAB BARS / BARRES D'APPUI

## MANIGLIONI MURALI INOX/INOX GRAB BARS/BARRES D'APPUI INOX

GARANZIA 2 ANNI - 2 YEARS WARRANTY - 2 ANS GARANTIE

**MANIGLIONI MURALI**

Acciaio Inox AISI 304 (18/10) brillante  
 Ø del tubo: 32 mm  
 Spessore: 1 mm

**WALL-MOUNTED GRAB BARS**

Shining Stainless Steel AISI 304 (18/10)  
 External Tube Ø: 32 mm  
 Thickness: 1 mm

**BARRES D'APPUI INOX**

Acier inox AISI 304 brillant  
 External Tube Ø: 32 mm  
 Épaisseur: 1 mm

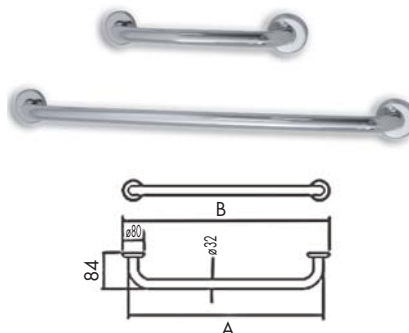

Cod.	Lunghezza/Lenght A	Lunghezza/Lenght B
105301	480 mm	530 mm
105304	840 mm	890 mm

**MANIGLIONE MURALE RECLINABILE A PARETE****WALL-MOUNTED SWING HAND RAIL/BARRE D'APPUI FLEXIBLE MURALE**

GARANZIA 2 ANNI - 2 YEARS WARRANTY - 2 ANS GARANTIE

Acciaio Inox AISI 304 (18/10)  
 Spessore della placca: 5 mm  
 Ø del tubo: 32 mm  
 Spessore tubo: 1,2 mm  
 Fissaggio murale in 4 punti (viti di fissaggio incluse)

Shining Stainless Steel AISI 304 (18/10)  
 Fixing plate: 5 mm thickness  
 External Tube Ø: 32 mm  
 Thickness: 1,2 mm  
 4 points fixing (Stainless steel screws included)

Acier inox AISI 304 brillant  
 Plaque de fixation: 5 mm d'épaisseur  
 External Tube Ø: 32 mm  
 Épaisseur: 1,2 mm  
 Montage mural en 4 points (Vís en acier inoxydable inclus)

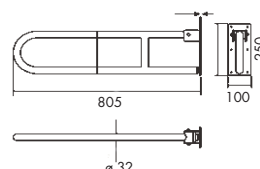

Cod.	Descrizione
105305	Inox AISI 304 / Stainless Steel AISI 304

**MANIGLIONE PIEGATO MURALE CON PORTA SAPONE****CURVED GRAB BAR WITH SOAP HOLDER/POIGNÉE INOX AVEC PORTE SAVON**

GARANZIA 2 ANNI - 2 YEARS WARRANTY - 2 ANS GARANTIE

Acciaio Inox AISI 304 (18/10)  
 Ø del tubo: 25 mm  
 Angolo di piega: 135°  
 Destro e sinistro

Shining Stainless Steel AISI 304 (18/10)  
 External Tube Ø: 25 mm  
 Angle of bending: 135°  
 Can be used on left or right side

Acier inox AISI 304 brillant  
 External Tube Ø: 25 mm  
 Angle de cintrage: 135°  
 Droite et gauche

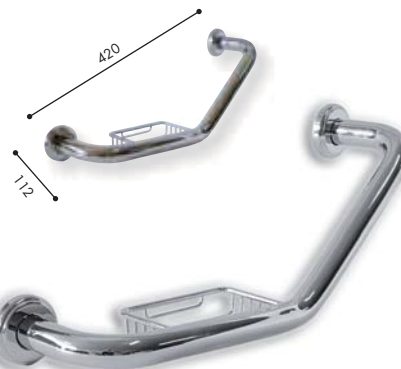

Cod.	Descrizione
105306	Inox AISI 304 / Stainless Steel AISI 304

LINEA ABS

🇮🇹 **DISTRIBUTORI DI CARTA IGIENICA**

🇬🇧 **TOILET PAPER DISPENSERS**

🇫🇷 **DISTRIBUTEURS A PAPIER TOILET**

**GARANZIA 2 ANNI - 2 YEARS WARRANTY - 2 ANS GARANTIE**



**ROLL ABS 400 MT. BASIC**

ABS bianco  
400 mt: rotolo Ø 300 mm max, Ø mandrino: 45 e 70 mm

ABS white  
400 mt: roll Ø 300 mm max, Ø mandrel: 45 e 70 mm

ABS blanc  
400 mt: rouleau Ø 300 mm max, Ø broche: 45 e 70 mm

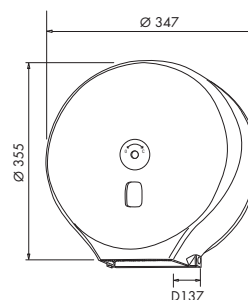

Peso / Weight / Poids: Kg. 1,2



**ROLL ABS 200 MT. BASIC**

ABS bianco  
200 mt: rotolo Ø 255 mm max, Ø mandrino: 45 e 70 mm

ABS white  
200 mt: roll Ø 255 mm max, Ø mandrel: 45 e 70 mm

ABS blanc  
200 mt: rouleau Ø 255 mm max, Ø broche: 45 e 70 mm

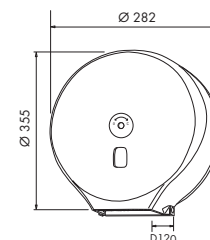

Peso / Weight / Poids: Kg. 0,7

🇮🇹 **DISTRIBUTORI DI CARTA ASCIUGAMANI**

🇬🇧 **HAND PAPER DISPENSERS**

🇫🇷 **DISTRIBUTEURS A PAPIER**

**GARANZIA 2 ANNI - 2 YEARS WARRANTY - 2 ANS GARANTIE**



**MAXI 400 FOGLI / SHEETS / FEUILLES**

ABS bianco per carta piegata a "C", "Z" e "M"  
White ABS suitable for "C", "Z" and "M" fold  
Distributeur papier blanc, en ABS (feuilles "C", "Z" et "M")

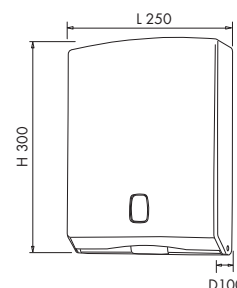

Peso / Weight / Poids: Kg. 1,5



**MINI 200 FOGLI / SHEETS / FEUILLES**

ABS bianco per carta piegata a "C", "Z" e "M"  
White ABS suitable for "C", "Z" and "M" fold  
Distributeur papier blanc, en ABS (feuilles "C", "Z" et "M")

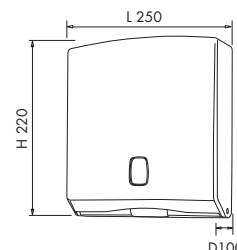

Peso / Weight / Poids: Kg. 1,2

LINEA ABS

- 🇮🇹 **DISTRIBUTORI DI SAPONE**
- 🇬🇧 **SOAP DISPENSERS**
- 🇫🇷 **DISTRIBUTEURS A SAVON**

**GARANZIA 2 ANNI - 2 YEARS WARRANTY - 2 ANS GARANTIE**



**DISA/P 1000 BASIC**

Distributore di sapone in ABS capacità 1 litro.  
*ABS soap dispenser 1 ltr.*  
 Distributeur a savon 1 litre

**SISTEMA PUSH – PUSH SYSTEM**

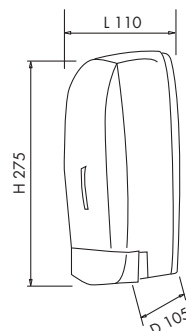

Peso / Weight / Poids: Kg. 0,7  
 Per tutti i tipi di sapone salvo a microgranuli  
*Accepts all kinds of soap except the Microgranules*



**DISA/P 500 BASIC**

Distributore di sapone in ABS capacità 0,5 litri.  
*ABS soap dispenser 0,5 ltr.*  
 Distributeur a savon 0,5 litre.

**SISTEMA PUSH – PUSH SYSTEM**

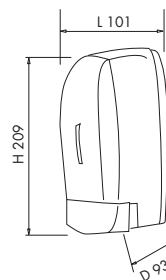

Peso / Weight / Poids: Kg. 0,4  
 Per tutti i tipi di sapone salvo a microgranuli  
*Accepts all kinds of soap except the Microgranules*



**MONET**

Dosapone elettronico in ABS funzionante a batteria  
 (4 pile stilo), capacità 1,1 litri, dosaggio 1 ml.  
*Electronic soap dispenser in ABS, battery operating,  
 capacity 1,1 ltr., dosing 1 ml.*  
 Distributeur a savon automatique 1,1 lt., dosage 1 ml.

**SISTEMA AUTOMATICO – AUTOMATIC SYSTEM**

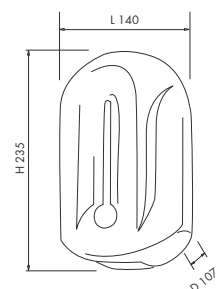

Peso / Weight / Poids: Kg. 0,7  
 Per tutti i tipi di sapone salvo a microgranuli  
*Accepts all kinds of soap except the Microgranules*

**DISTRIBUTORI DI SACCHETTI IGIENICI  
 SANITARY TOWEL BAGS DISPENSERS/DISTRIBUTEUR DE SACS SANITAIRES**

**GARANZIA 2 ANNI - 2 YEARS WARRANTY - 2 ANS GARANTIE**



**DISIGIENICO ABS**

Distributore di sacchetti igienici, ABS bianco  
*Sanitary towel bags dispensers, white ABS*  
 Distributeur de sacs sanitaires en ABS

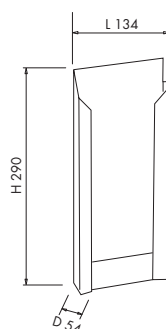

Peso / Weight / Poids: Kg. 0,4



LINEA ABS

**DISTRIBUTORE DI CARTA IN BOBINA MAXI**  
**CENTER PULL DISPENSER MAXI/DISTRIBUTEUR PAPIER EN ROUL**  
**GARANZIA 2 ANNI - 2 YEARS WARRANTY - 2 ANS GARANTIE**

Distributore di carta in ABS  
 Dispenser per rotolo asciugamano a sfilamento centrale  
 Dimensioni max rotolo: Ø 245 x 265 mm

*Center pull dispenser maxi in ABS*  
*For paper wipers in roll*  
*Distribution by the center*  
*Maximun roll dimensions: Ø 245 x 265 mm*

Distributeur papier en roul en ABS,  
 avec distribution central  
 Dimension max. roul Ø 245 x 265 mm

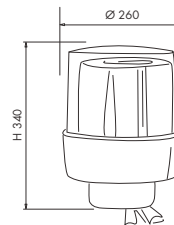

Cod.	Descrizione
700519	Maxi bianco - trasparente / Trasparent - white



**PORTASCOPINO MURALE**  
**WALL MOUNTING TOILET BRUSH / PORTE BALAI WC MURAL**  
**GARANZIA 2 ANNI - 2 YEARS WARRANTY - 2 ANS GARANTIE**

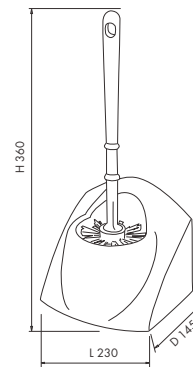

Polipropilene, fissaggio murale in 2 punti  
 Polypropylene, wall mounting support in 2 points  
 Polypropylène, montage mural en 2 points

**VERSIONE INOX VEDI PAG. 55 / INOX VERSION PAG. 55**





















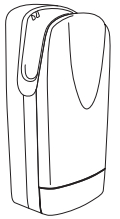

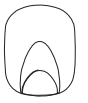

































-  Alcuni articoli sono soggetti a minimo d'ordine, verificare con l'ufficio commerciale
-  Check with the sales office minimum order items
-  Certains articles sont soumis à commande minimale, consultez le bureau de ventes



















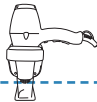



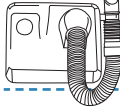



















# ALLEGATI / ANNEXES / ANNEXES

ALTEZZA INSTALLAZIONE RACCOMANDATA / RECOMMENDED INSTALLATION HEIGHT /  
HAUTEUR D'INSTALLATION RECOMMANDÉE

## ASCIUGAMANI / HAND DRYERS / SÈCHE-MAINS

								
								
120 cm 	100 cm 	125 cm 	125 cm 	125 cm 	125 cm 	125 cm 	125 cm 	125 cm 
115 cm 	95 cm 	120 cm 	120 cm 	120 cm 	120 cm 	120 cm 	120 cm 	120 cm 
105 cm 	85 cm 	95 cm 	95 cm 	95 cm 	95 cm 	95 cm 	95 cm 	95 cm 
105 cm 	85 cm 	95 cm 	95 cm 	95 cm 	95 cm 	95 cm 	95 cm 	95 cm 

## ASCIUGACAPELLI / HAIR DRYERS / SÈCHE-CHEVEUX

						
						
130 cm 	130 cm 	180 cm 	180 cm 	180 cm 	160 cm 	160 cm 
130 cm 	130 cm 	170 cm 	170 cm 	170 cm 	150 cm 	150 cm 
100 cm 	100 cm 	130 cm 	130 cm 	130 cm 	130 cm 	130 cm 
100 cm 	100 cm 	135 cm 	135 cm 	135 cm 	135 cm 	135 cm 

## ASCIUGACAPELLI LINEA HOTEL / HOTEL HAIR DRYERS / SÈCHE-CHEVEUX POUR HOTEL



ALTEZZA DAL SUOLO: 1,55 MT.  
FLOOR HEIGHT: 1,55 MT.  
POSITIONNEMENT À 1,55 MT. DU SOL

**NO USO COLLETTIVO  
NO HEAVY TRAFFIC  
NO PASSAGE ÉLEVÉE**











***wama***<sup>®</sup>

VAMA ELETTROTERMO MECCANICA srl  
Via Damiano Chiesa, 37  
20026 Novate Milanese (MI) - Italy  
Tel. +39 02 59903050 • Fax +39 02 59903067  
[www.wama.it](http://www.wama.it) • [info@wama.it](mailto:info@wama.it)