

**ECCO** Stream **ECCO** Flow

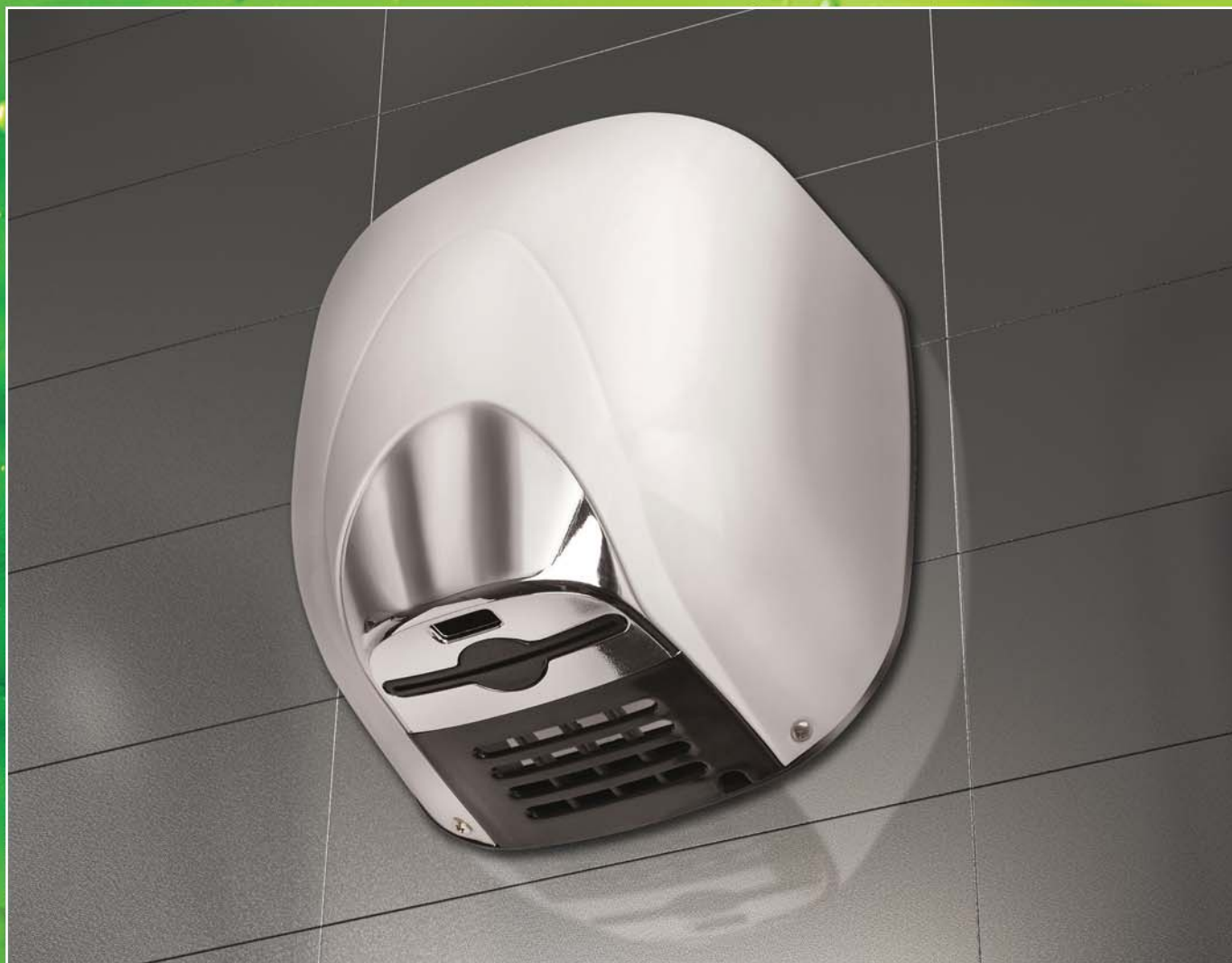

**VELOCITÀ ASCIUGATURA**  
*DRYING TIME / TEMPS DE SÉCHAGE*



**RISPARMIO ENERGETICO**  
*ENERGY SAVING / ÉPARGNE ENERGETIQUE*



**SILENZIOSITÀ**  
*NOISELESS / SILENCIEUX*



**DESIGN**



**ANTIVANDALISMO**  
*ANTIVANDALISM / ANTIVANDALISME*





# EcoStream EcoFlow

ECO-JET DRYERS

ASCIUGAMANI - HAND DRYERS - SÈCHE-MAINS



-  - **67 VOLTE PIU' ECONOMICO**  
RISPETTO AI ROTOLI DI COTONE
- **52 VOLTE PIU' ECONOMICO**  
RISPETTO ALLA CARTA
- **7 VOLTE PIU' ECONOMICO**  
RISPETTO AGLI ASCIUGAMANI TRADIZIONALI

-  - **67 TIMES BETTER**  
THAN COTTON DISPENSING RENT SERVICES
- **52 TIMES BETTER**  
THAN PAPER
- **7 TIMES BETTER**  
THAN TRADITIONAL HAND DRYERS

-  - **67 FOIS MIEUX**  
QUE LE COTON
- **52 FOIS MIEUX**  
QUE LE PAPIER
- **7 FOIS PLUS EFFICACE**  
QUE LE SÈCHE-MAINS ÉLECTRIQUE TRADITIONNEL



**NUOVE VERSIONI  
NEW MODELS  
NOUVEAUX MODÈLES**



325 km/h



276 km/h

**GARANZIA 3 ANNI • WARRANTY 3 YEARS • GARANTIE 3 ANS**

**MADE  
IN ITALY**

CE



WEEE



## GUIDA ALLA SCELTA / HOW TO CHOOSE / COMMENT CHOISIR

1

🇮🇹 SCEGLI: CONO D'ARIA (EcoSTREAM) o LAMA D'ARIA (EcoFLOW)?



🇬🇧 CHOOSE: HOLE (EcoSTREAM) OR BLADE (EcoFLOW)?

🇫🇷 SELECTIONNER: CONE D'AIR (EcoSTREAM) OU LAME D'AIR (EcoFLOW)?

2

🇮🇹 SCEGLI IL MODELLO

🇬🇧 CHOOSE THE MODEL

🇫🇷 CHOISISSEZ LE MODÈLE

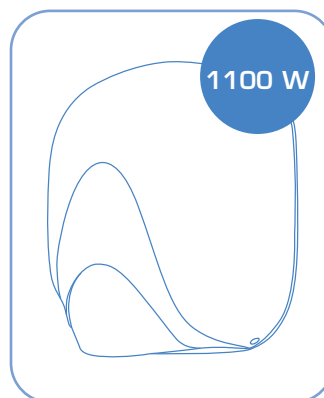
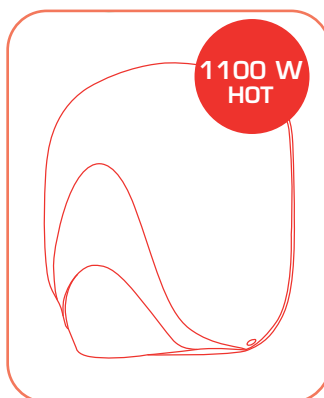
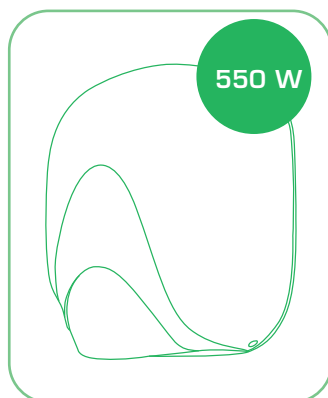

🇮🇹 ECOLOGICO: IL MAGGIOR RISPARMIO ENERGETICO

🇬🇧 GREENEST: ENERGY SAVING TOP PERFORMER

🇫🇷 ECOLOGIQUE: ECONOMIE D'ÉNERGIE ABSOLUE

ARIA CALDA IMMEDIATA!  
MOTORE 550 W +  
RESISTENZA 550 W

IMMEDIATELY HOT AIR!  
550 W MOTOR +  
550 W HEATING ELEMENT

AIR CHAUD IMMÉDIATEMENT!  
550 W MOTEUR +  
550 W CHAUFFAGE

POTENZA ASSOLUTA:  
IL PIÙ VELOCE

POWERFUL:  
THE FASTEST ONE

PUISSANT:  
LE PLUS RAPIDE

3

🇮🇹 SCEGLI LA COVER

🇬🇧 CHOOSE YOUR FAVOURITE COVER

🇫🇷 CHOISISSEZ VOTRE COUVERTURE FAVORITE



ABS bianco, automatico  
*white ABS, sensor operating*  
ABS blanc, capteur

alluminio bianco, automatico  
*white metal, sensor operating*  
metal blanc, capteur

alluminio satinato, automatico  
*satin metal, sensor operating*  
metal satin, capteur

alluminio cromato, automatico  
*chrome metal, sensor operating*  
metal chromé, capteur





550 W - 1100 W

**TEMPO DI ASCIUGATURA: 10 - 15 sec - VELOCITA' ARIA 325 km/h (versione 1100 W)**

**IGIENE INTEGRATA**

Il filtro EPA E11 (opzione) garantisce protezione contro oltre il 97,66 % dei batteri presenti nell'aria che viene utilizzata durante l'asciugatura.

**RISPARMIO ENERGETICO ASSOLUTO: SOLO 2,3 W PER ASCIUGATURA (versione 550 W)**

- oltre 52 volte più economico rispetto alla carta (550 W)
- 85 % - 90 % di risparmio rispetto ai modelli di asciugamani tradizionali

**MOTORE STANDARD AC ALTA PRESSIONE**

**ASSENZA DI RESISTENZA ELETTRICA:** riscaldamento dell'aria per compressione ed attraverso il calore dei motori, abbattendo i consumi e minimizzando i costi manutenzione.

**DRYING TIME: 10 - 15 sec - AIR SPEED 325 km /h (1100 W version)**

**INTEGRATED HYGIENIC SYSTEM**

EPA E11 filter (option) allows protection against 97,66 % of air bacteria, spreading clean air on hands.

**ECOLOGICAL HAND DRYER, THE LOWEST POWER CONSUMPTION: ONLY 2,3 W per drying cycle (550 W version)**

- SAVE 52 times than paper (550 W)
- SAVE 85 % - 90 % than traditional hand dryers

**AC STANDARD MOTOR HIGH PRESSURE**

**NO HEATING ELEMENT:** air heating through compression and engines warming, reducing energy consumption and minimizing maintenance costs.

**TEMPS DE SÈCHAGE: 10 - 15 sec - VITESSE D'AIR 325 kilomètres par heure (Version 1100 W)**

**HYGIÈNE INTÉGRÉE**

Le filtre EPA E11 (en option) offrant une protection de plus 99.997 % des bactéries aéroportées qui est utilisée pendant le séchage.

**ÉCONOMIE D'ÉNERGIE ABSOLUE: SEULEMENT 2,3 WATT POUR LE SÈCHAGE (Version 550 W)**

- Plus de 52 fois d'économie par rapport au papier (550 W)
- 85 % - 90 % d'économie par rapport aux modèles traditionnels de sèche-mains

**STANDARD MOTEUR AC HAUTE PRESSION**

**ABSENCE DE RÉSISTANCE ÉLECTRIQUE:** chauffage de l'air grâce à la compression et à la chaleur des moteurs, ce qui réduit la consommation d'énergie et les coûts de maintenance.

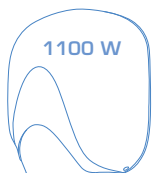

**NESSUNA RESISTENZA ELETTRICA:  
RISCALDAMENTO PROGRESSIVO CON L'UTILIZZO**

**NO HEATING ELEMENT:  
PROGRESSIVE AIR HEATING**

**ABSENCE DE RÉSISTANCE ÉLECTRIQUE:  
CHAUFFAGE AIR PROGRESSIF**

ASCIUGAMANI - HAND DRYERS - SÈCHE-MAINS



### 1100 W HOT

**MODELLI CON RESISTENZA ELETTRICA 550 W + MOTORE 550 W, TOT. 1100 W**

Perfetto equilibrio tra velocità di asciugatura / risparmio energetico / rumorosità  
Il comfort dell'aria calda fin dal primo utilizzo, con un risparmio energetico eccezionale

**MODELS WITH 550 W MOTOR + 550 W HEATING ELEMENT, TOT. 1100 W**

Perfect balance between drying speed / power saving / noise  
Immediately warm air for a more comfortable drying experience, with exceptional power saving

**MODÈLES AVEC CHAUFFAGE ELECTRIQUE 550 W + MOTEUR 550 W, TOT. 1100 W**

L'équilibre parfait entre vitesse de séchage / économie d'énergie / bruit  
Le confort de l'air chaud à partir de la première utilisation, avec économie d'énergie exceptionnelle



- ARIA CALDA IMMEDIATA!!!**
- IMMEDIATELY HOT AIR!!!**
- AIR CHAUD IMMEDIATEMENT!!!**



Il filtro EPA E11 (opzione) garantisce protezione contro il 97,66% dei batteri\* presenti nell'aria che viene utilizzata durante l'asciugatura

*EPA E11 filter (option) allows protection against 97,66% of bacteria\*, spreading clean air on hands*

Le filtre EPA E11 (en option) assure une protection de 97,66% contre les bactéries\* contenues dans l'air au cours du séchage

\* Certificato da ALTFILTER - Certificate from ALTFILTER - Certification ALTFILTER



**COVER IN ALLUMINIO CON VERNICIATURA DI COLORE NERO METALLIZZATO, FINITURA GOFRATA**

DISPONIBILE PER TUTTE LE VERSIONI 550 - 1100 - 1100 HOT



**METAL COVER, BLACK METALLIC PAINT, EMBOSSED FINISH**

AVAILABLE FOR ALL VERSIONS 550 - 1100 - 1100 HOT

**COVER EN METAL AVEC PEINTURE MÉTALLISÉE NOIRE, FINITION EN RELIEF**

DISPONIBLE POUR TOUTES LES VERSIONS 550 - 1100 - 1100 HOT

ASCIUGAMANI - HAND DRYERS - SÈCHE-MAINS

-  **ARTICOLI & CODICI PRODOTTO**
-  **MODEL REFERENCE CHART**
-  **TABLEAU DES MODÈLE DE RÉFÉRENCE**



Cod.	Mod.			Cod.	Mod.		
EST ABS 550	ECOstream	ABS Bianco / White / Blanc	550W	EFL ABS 550	ECOflow	ABS Bianco / White / Blanc	550W
EST ABS 1100	ECOstream	ABS Bianco / White / Blanc	1100W	EFL ABS 1100	ECOflow	ABS Bianco / White / Blanc	1100W
EST BF 550	ECOstream	Metallo Bianco White metal / Metal blanc	550W	EFL BF 550	ECOflow	Metallo Bianco White metal / Metal blanc	550W
EST BF 1100	ECOstream	Metallo Bianco White metal / Metal blanc	1100W	EFL BF 1100	ECOflow	Metallo Bianco White metal / Metal blanc	1100W
EST LF 550	ECOstream	Metallo Cromato Chrome metal / Metal chromé	550W	EFL LF 550	ECOflow	Metallo Cromato Chrome metal / Metal chromé	550W
EST LF 1100	ECOstream	Metallo Cromato Chrome metal / Metal chromé	1100W	EFL LF 1100	ECOflow	Metallo Cromato Chrome metal / Metal chromé	1100W
EST SF 550	ECOstream	Metallo Satinato Satin metal / Metal satin	550W	EFL SF 550	ECOflow	Metallo Satinato Satin metal / Metal satin	550W
EST SF 1100	ECOstream	Metallo Satinato Satin metal / Metal satin	1100W	EFL SF 1100	ECOflow	Metallo Satinato Satin metal / Metal satin	1100W



Cod.	Mod.			Cod.	Mod.		
EST ABS 1100 HOT	ECOstream	ABS Bianco / White / Blanc	1100W	EFL ABS 1100 HOT	ECOflow	ABS Bianco / White / Blanc	1100W
EST BF 1100 HOT	ECOstream	Metallo Bianco White metal / Metal blanc	1100W	EFL BF 1100 HOT	ECOflow	Metallo Bianco White metal / Metal blanc	1100W
EST LF 1100 HOT	ECOstream	Metallo Cromato Chrome metal / Metal chromé	1100W	EFL LF 1100 HOT	ECOflow	Metallo Cromato Chrome metal / Metal chromé	1100W
EST SF 1100 HOT	ECOstream	Metallo Satinato Satin metal / Metal satin	1100W	EFL SF 1100 HOT	ECOflow	Metallo Satinato Satin metal / Metal satin	1100W



**OPZIONE FILTRO EPA E11 (TUTTI I MODELLI)**  
**EPA E11 FILTER OPTION (ALL MODELS)**  
**FILTRE EPA E11 EN OPTION (TOUS LES MODÈLES)**

### ASCIUGAMANI - HAND DRYERS - SÈCHE-MAINS

- CONFRONTO COSTI DI ASCIUGATURA ANNUALI
- ANNUAL SAVINGS CALCULATION
- CALCULEZ VOS COÛTS/ECONOMIES ANNUELLES

N° UTILIZZI GIORNALIERI DAILY USE UTILISATION PAR JOUR	ECOSTREAM ECOFLOW 1100W	ECOSTREAM ECOFLOW 550W	VAMA TORNADO PROTECH®	COTONE COTTON COTON	CARTA PAPER PAPIER	ASCIUGAMANI TRADIZIONALI 2400 W TRADITIONAL HAND DRYERS 2400 W SÈCHE-MAINS STANDARD 2400 W
100	€ 22,05/anno	€ 13,89/anno	€ 30,04	€ 949,00	€ 730,00	€ 104,04
200	€ 44,10/anno	€ 27,79/anno	€ 58,55	€ 1.898,00	€ 1.460,00	€ 205,91
400	€ 88,19/anno	€ 55,57/anno	€ 115,52	€ 3.504,00	€ 2.920,00	€ 409,65



Calcoli basati su 100 / 200 / 400 utilizzi al giorno nonché sull'utilizzo di 1 unità. Costo dell'energia di € 0,1655/kWh; costo di € 0,01 per salvietta di carta, con una media di 2 salviette per asciugatura. I costi effettivi possono variare.



Based on 100 / 200 / 400 uses per day. Energy cost € 0,1655/kWh; paper cost € 0,01 per sheet, with use of two sheets at once.



Calculs basés sur 100 / 200 / 400 utilisations par jour et l'utilisation de 1 unité. Coût en énergie de € 0,1655 / kWh; coût de € 0,01 pour les serviettes en papier, avec une moyenne de 2 serviettes de toilette pour le séchage. Coûts réels peuvent varier.

#### CARATTERISTICHE TECNICHE / TECHNICAL FEATURES / CARACTÉRISTIQUES TECHNIQUES

Funzionamento	Sensore di rilevam. elettronico a raggi infrarossi	Volume aria	
Functioning	Sensor operating	Air Flow	187 m <sup>3</sup> /h - 52 l/s (1100 W), 126 m <sup>3</sup> /h - 35 l/s (550 W)
Activation	Capteur électronique	Débit d'air	
Ciri al minuto		Peso	
Tr min	30000 rpm (1100 W) - 26000 rpm (550 W)	Weight	5,00 Kg (Metallo) - 3,00 Kg (ABS)
Révolutions par minute		Poids net	
Grado di protezione elettrica		Materiale	ABS - Alluminio pressofuso
Electrical Protection Level	IP23 - CLASS II	Materials	ABS - Die Cast Aluminium
Isolation électrique		Matériel	ABS - en fonte d'aluminium
Tensione		Marchi di qualità	
Supply Voltage	220 V-240 V	Quality marks - certifications	CE
Tension d'alimentation		Certification	
Potenza totale		Rumorosità (2 mt)	
Total power	1100 W - 550 W	Noise Level (2 mt)	80 db (1100 W) 75 db (550 W)
Puissance totale		Niveau sonore (2 mt)	
Potenza resistenza		Garanzia	3 anni*
Absorption Heating Element	550 W (solo - only - seule mod. HOT)	Warranty	3 years*
Puissance chauffage		Garantie	3 ans*
Potenza motore			
Absorption Motor	1100 W - 550 W		
Puissance moteur			
Dimensioni A x L x P			
Dimensions H x W x D	285 X 221 X 157 mm		
Dimensions H x L x P			
Frequenza			
Frequency	50-60 Hz		
Fréquence			
Velocità aria			
Air Speed	325 km/h (1100 W) - 250 km/h (550 W)		
Vitesse d'air			

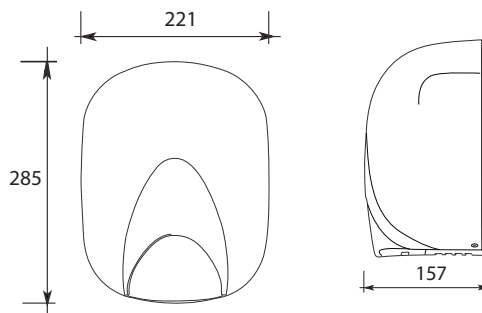

\* Per le limitazioni di garanzia si vedano le condizioni generali di servizio

\* Limited warranty. Please have a look to the General Warranty Conditions for details and consumables

\* Limitations de garantie: revoir Conditions de Garantie Generale