

vanna®

Stream
DRY
UV

 **MADE
IN ITALY**



L'eccellenza **MADE IN ITALY**
dell'asciugamani elettrico

Stream Dry UV



VELOCITÀ ASCIUGATURA
DRYING TIME / TEMPS DE SÉCHAGE



RISPARMIO ENERGETICO
ENERGY SAVING / ÉPARGNE ENERGETIQUE



SILENZIOSITÀ
NOISELESS / SILENCIEUX



DESIGN



ANTIVANDALISMO
ANTIVANDALISM / ANTIVANDALISME



STREAM DRY UV

ECO-JET DRYERS

ASCIUGAMANI - HAND DRYERS - SÈCHE-MAINS



 - **67 VOLTE PIÙ ECONOMICO**

RISPETTO AI ROTOLI DI COTONE

- **52 VOLTE PIÙ ECONOMICO**

RISPETTO ALLA CARTA

- **7 VOLTE PIÙ ECONOMICO**

RISPETTO AGLI ASCIUGAMANI TRADIZIONALI

 - **67 TIMES BETTER**

THAN COTTON DISPENSING RENT SERVICES

- **52 TIMES BETTER**

THAN PAPER

- **7 TIMES BETTER**

THAN TRADITIONAL HAND DRYERS

 - **67 FOIS MIEUX**

QUE LE COTON

- **52 FOIS MIEUX**

QUE LE PAPIER

- **7 FOIS MIEUX**

QUE LE SÈCHE-MAINS ÉLECTRIQUE TRADITIONEL





GARANZIA 3 ANNI • WARRANTY 3 YEARS • GARANTIE 3 ANS



STREAM DRY UV

ASCIUGAMANI - HAND DRYERS - SÈCHE-MAINS

-  - **VELOCITÀ 300 KM/H**
ASCIUGATURA SUPER VELOCE IN 10-15 SECONDI
 - **MOTORE TOP-AC**
AD ALTISSIME PRESTAZIONI
 - **MASSIMO RISPARMIO ENERGETICO**
SOLO 550 WATT (1100 WATT CON RESISTENZA, ATTIVABILE DAL GESTORE)
 - **FILTRO EPA E11**
ASSENZA DI BATTERI E VIRUS NELL'ARIA EROGATA
 - **LAMPADA UV ANTIBATTERICA**
SEMPRE ATTIVA PER DISINFEZIONE INTERNA
-  - **300 KM/H ULTRA FAST HAND DRYING**
IN 10-15 SECONDS
 - **TOP-AC MOTOR**
TOP PERFORMANCE
 - **TOP ENERGY SAVING:**
550 WATT ONLY (1100 WATT WITH HEATING ELEMENT MANAGEABLE BY OWNER)
 - **EPA E 11 FILTER**
LACK OF BACTERIES AND VIRUSES IN THE AIR
 - **UV LAMP ALWAYS ON**
FOR INSIDE DISINFECTION
-  - **VITESSE DE L'AIR 300 KM/H**
SECHAGE RAPIDE EN 10/15 SECONDES
 - **MOTEUR TOP-AC**
TRÈS HAUTE PERFORMANCE
 - **ECONOMIE D'ENERGIE MAXIMALE**
SEULEMENT 550 W (1100 W AVEC RÉSISTANCE ACTIVÉ PAR LE BOUTON ON-OFF)
 - **FILTRE EPA E11**
ABSENCE DE BACTÉRIES ET DE VIRUS DANS L'AIR FOURNI
 - **LAMPE ANTIBACTERIENNE UV**
TOJOURS ACTIF POUR LA DÉSINFECTION INTERN

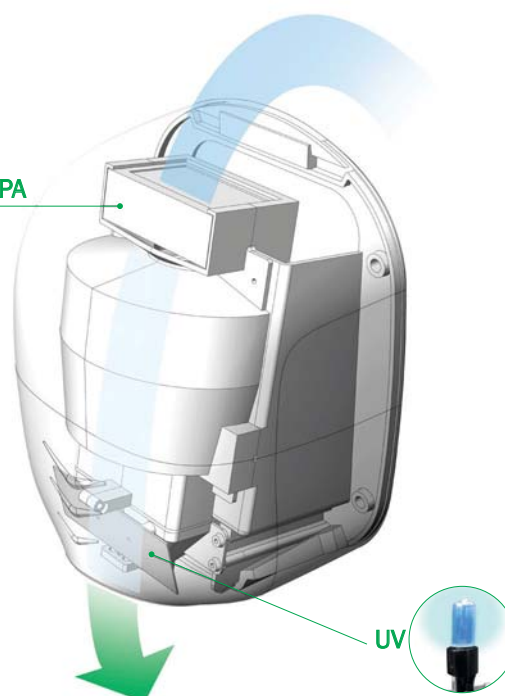

Filtro EPA / EPA filter / Filtre EPA



STREAM DRY UV

ECO-JET DRYERS

ASCIUGAMANI - HAND DRYERS - SÈCHE-MAINS

-  **ARTICOLI & CODICI PRODOTTI**
-  **MODEL REFERENCE CHART**
-  **TABLEAU DES MODÈLE DE RÉFÉRENCE**



-  **FILTRO EPA INCLUSO**
-  **EPA FILTER INCLUDED**
-  **FILTRE EPA INCLUS**

Cod.

STREAM DRY UV ABS	Polipropilene bianco / Polypropylene white / Polypropylène blanc
STREAM DRY UV BF	Acciaio verniciato bianco / Stainless steel white / Acier blanc
STREAM DRY UV LF	Acciaio inox AISI 304 lucido / Bright AISI 304 stainless steel / Acier inox Aisi 304 brillant
STREAM DRY UV SF	Acciaio inox AISI 304 satinato / Satin AISI 304 stainless steel / Acier AISI 304 satin
STREAM DRY UV NF	Acciaio con verniciatura gofrata nera / Black metallic paint, embossed finish / Acier avec peinture métallisée noire, finition en relief



ABS



BF



SF





LF





NF





-  **LAMPADA UV: per disinfezione del condotto di ventilazione**
-  **UV LAMP: for air enclosure disinfection**
-  **LAMPADE UV: pour disinfection de la chambre d-air**



-  **FILTRO EPA E11: garantisce protezione contro il 97,66% dei batteri**
-  **EPA FILTER E11: allows protection against 97,66% of bacteria**
-  **FILTRE EPA E11: assure une protection contre 97,66% des bactéries**



-  **RESISTENZA ON-OFF**
-  **HEATING ON-OFF**
-  **CHAUFFAGE ON-OFF**

STREAM DRY UV

ASCIUGAMANI - HAND DRYERS - SÈCHE-MAINS

- 🔗 CONFRONTO COSTI DI ASCIUGATURA ANNUALI
- 🌸 ANNUAL SAVINGS CALCULATIONS
- 🔗 CALCULEZ VOS COÛTS/ECONOMIES ANNUELLES

N° UTILIZZI GIORNALIERI DAILY USE UTILISATION PAR JOUR	 1100 W	COTONE COTTON COTON	CARTA PAPER PAPIER	ASCIUGAMANI TRADIZIONALI 2400 W TRADITIONAL HAND DRYERS 2400 W SÈCHE-MAINS STANDARD 2400 W
100	€ 22,05/anno	€ 949,00	€ 730,00	€ 104,04
200	€ 44,10/anno	€ 1.898,00	€ 1.460,00	€ 205,91
400	€ 88,19/anno	€ 3.504,00	€ 2.920,00	€ 409,65

STREAM DRY UV

VAMA

CARATTERISTICHE TECNICHE / TECHNICAL FEATURES / CARACTÉRISTIQUES TECHNIQUES

Funzionamento	Sensore di rilevam. elettronico a raggi infrarossi
Functioning	Sensor operating
Activation	Capteur électronique
Giri al minuto	
Tr min	26000 rpm
Révolutions par minute	
Grado di protezione elettrica	
Electrical Protection Level	IP23 - CLASS II
Isolation électrique	
Tensione	
Supply Voltage	220 V-240 V
Tension d'alimentation	
Potenza totale	
Total power	1100 W
Puissance totale	
Potenza resistenza	
Absorption Heating Element	550 W (ON-OFF)
Puissance chauffage	
Potenza motore	
Absorption Motor	550 W
Puissance moteur	
Dimensioni A x L x P	
Dimensions H x W x D	285 X 221 X 157 mm
Dimensions H x L x P	
Frequenza	
Frequency	50-60 Hz
Fréquence	
Velocità aria	
Air Speed	300 km/h
Vitesse d'air	

Volume aria	
Air Flow	187 m ³ /h - 52 l/s
Débit d'air	
Peso	
Weight	2,55 Kg Polipropilene - 3,05 Kg Acciaio Inox
Poids net	
Materiale	Polipropilene - Acciaio Inox AISI 304
Materials	Polipropilene - Stainless steel AISI 304
Matériel	Polipropilene - Acier Inox AISI 304
Marchi di qualità	
Quality marks - certifications	CE
Certification	
Rumorosità (2 mt)	
Noise Level (2 mt)	75 db
Niveau sonore (2 mt)	
Garanzia	3 anni*
Warranty	3 years*
Garantie	3 ans*

Accessori inclusi - Included: FILTRO EPA E11, LAMPADA UV

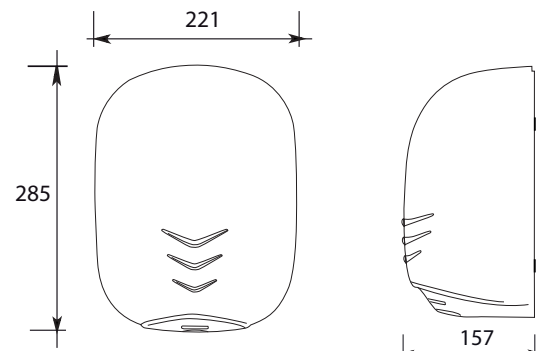

- 🔗 Per le limitazioni di garanzia si vedano le condizioni generali di servizio
- 🌸 Limited warranty. Please have a look to the General Warranty Conditions for details ans consumable
- 🔗 Limitations de garantie: revoir Conditions de Garantie Generale